

**ATP-4310**  
**ATP-4610**

**THERMAL TRANSFER / DIRECT THERMAL  
BAR CODE PRINTER**

**USER'S  
MANUAL**

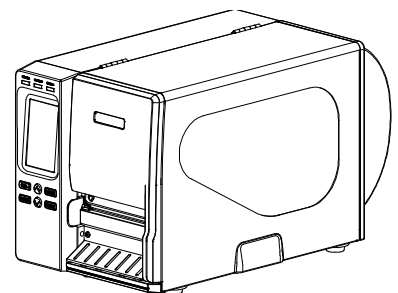

## **Copyright Information**

The copyright in this manual, the software and firmware in the printer described therein are owned by the company.

CG Triumvirate is a trademark of Agfa Corporation. CG Triumvirate Bold Condensed font is under license from the Monotype Corporation. Windows is a registered trademark of Microsoft Corporation.

All other trademarks are the property of their respective owners.

Information in this document is subject to change without notice and does not represent a commitment on the part of the company. No part of this manual may be reproduced or transmitted in any form or by any means, for any purpose other than the purchaser's personal use, without the expressed written permission of the company.

## Agency Compliance and Approvals

---



EN 55022 (Class A)  
EN 55024  
EN 61000-3-2 / EN 61000-3-3  
EN 60950-1

This is a class A product. In a domestic environment this product may cause radio interference in which case the user may be required to take adequate measures.

---



FCC CFR Title 47 Part 15B, Class A  
ICES-003, Class A

This equipment has been tested and found to comply with the limits for a Class A digital device, pursuant to Part 15 of the FCC Rules. These limits are designed to provide reasonable protection against harmful interference when the equipment is operated in a commercial environment.

This equipment generates, uses, and can radiate radio frequency energy and, if not installed and used in accordance with the manufacturer's instruction manual, may cause harmful interference with radio communications. Operation of this equipment in a residential area is likely to cause harmful interference, in which case you will be required to correct the interference at your own expense.

This Class A digital apparatus complies with Canadian ICES-003.  
Cet appareil numérique de la classe A est conforme à la norme NMB-003 du Canada.

---



AS/NZS CISPR 22 (Class A)

---



GB-4943.1  
GB9254 (Class A)  
GB17625.1

此为 A 级产品，在生活环境中，该产品可能会造成无线电干扰，在这种情况下，可能需要用户对干扰采取切实可行的措施。

---



UL 60950-1(2nd Edition)  
CSA C22.2 No. 60950-1-07(2nd Edition)

---



EN 60950-1

---

## Wichtige Sicherheits-Hinweise

1. Bitte lesen Sie diese Hinweis sorgfältig durch.
2. Heben Sie diese Anleitung für den späteren Gebrauch auf.
3. Vor jedem Reinigen ist das Gerät vom Stromnetz zu trennen. Verwenden Sie keine Flüssig-oder Aerosolreiniger. Am besten eignet sich ein angefeuchtetes Tuch zur Reinigung.
4. Die Netzanschluß-Steckdose soll nahe dem Gerät angebracht und leicht zugänglich sein.
5. Das Gerät ist vor Feuchtigkeit zu schützen.
6. Bei der Aufstellung des Gerätes ist auf sicheren Stand zu achten. Ein Kippen oder Fallen könnte Beschädigungen hervorrufen.
7. Beachten Sie beim Anschluß ans Stromnetz die Anschlußwerte.
8. Dieses Gerät kann bis zu einer Außentemperatur von maximal 40°C betrieben werden.

### CAUTION

Risk of explosion if battery is replaced by an incorrect type.

Dispose of used batteries according to the instructions.

### “VORSICHT”

Explosionsgefahr bei unsachgemäßen Austausch der Batterie. Ersatz nur durch denselben oder einem vom Hersteller empfohlenem ähnlichen Typ. Entsorgung gebrauchter Batterien nach Angaben des Herstellers.

### CAUTION:

Any changes or modifications not expressly approved by the grantee of this device could void the user's authority to operate the equipment.

#### CAUTION

1. HAZARDOUS MOVING PARTS IN CUTTER MODULE. KEEP FINGER AND OTHER BODY PARTS AWAY.
2. THE MAIN BOARD INCLUDES REAL TIME CLOCK FEATURE HAS LITHIUM BATTERY CR2032 INSTALLED. RISK OF EXPLOSION IF BATTERY IS REPLACED BY AN INCORRECT TYPE.
3. DISPOSE OF USED BATTERIES ACCORDING TO THE MANUFACTURER INSTRUCTIONS.

#### ATTENTION

1. PIÈCES DANGEREUSES EN MOUVEMENT DANS LE MODULE DE COUPAGE. GARDER VOS DOIGTS ET AUTRES PARTIES DU CORPS À L'ÉCART DE CES ZONES.
2. LE CIRCUIT PRINCIPAL CONTIENT UNE HORLOGE EN TEMPS RÉEL AVEC UNE BATTERIE AU LITHIUM DE TYPE CR2032. RISQUE D'EXPLOSION SI LA PILE EST REMPLACÉE PAR UNE PILE D'UN AUTRE TYPE.
3. SUIVRE LES INSTRUCTIONS DU FABRICANT POUR LA MISE AU REBUT DES PILES USÉES.

# Contents

- 1. Introduction..... 1
  - 1.1 Product Introduction ..... 1
  - 1.2 Product Features ..... 2
    - 1.2.1 Printer Standard Features** ..... 2
    - 1.2.2 Printer Optional Features** ..... 4
  - 1.3 General Specifications..... 5
  - 1.4 Print Specifications..... 5
  - 1.5 Ribbon Specifications ..... 5
  - 1.6 Media Specifications ..... 6
- 2. Operations Overview ..... 7
  - 2.1 Unpacking and Inspection ..... 7
  - 2.2 Printer Overview ..... 8
    - 2.2.1 Front View** ..... 8
    - 2.2.2 Interior view** ..... 10
    - 2.2.3 Rear View** ..... 11
  - 2.3 Operator Control..... 13
    - 2.3.1 LED Indication and Keys** ..... 15
    - 2.3.2 Touch Screen (MT series)** ..... 16
- 3. Setup ..... 18
  - 3.1 Setting up the printer ..... 18
  - 3.2 Loading the Ribbon ..... 19
    - 3.2.1 Loading the Ribbon** ..... 19
    - 3.2.2 Remove Used Ribbon** ..... 22
  - 3.3 Loading the Media ..... 23
    - 3.3.1 Loading the Media**..... 23
    - 3.3.2 Loading the Fan-fold/External Media**..... 27
    - 3.3.3 Loading Media in Peel-off Mode (Option)**..... 28
    - 3.3.4 Remove Liner from Internal Rewind (Option)** ..... 30
    - 3.3.5 Loading Media in Rewind Liner with Label Mode (Option)**..... 31
    - 3.3.6 Remove Labels from Internal Rewind (Option)**..... 32
- 4. Adjustment Knob ..... 33
  - 4.1 Print Head Pressure Adjustment knob ..... 33

4.2 Ribbon Tension Adjustment Module.....	34
4.3 Print Head Burn Line Adjustment Knob.....	35
4.4 Mechanism Fine Adjustment to Avoid Ribbon Wrinkles .....	36
5. LCD Menu Function for MT Series .....	38
5.1 Enter the Main Menu.....	38
5.2 Main Menu Overview .....	39
5.3 TSPL2.....	40
5.4 ZPL2 .....	42
5.5 Sensor.....	45
5.6 Interface.....	46
5.6.1 Serial Comm.....	46
5.6.2 Ethernet .....	47
5.7 File Manager .....	48
5.8 Diagnostics .....	49
5.8.1 Print Config.....	49
5.8.2 Dump Mode.....	51
5.8.3 Print Head.....	52
5.8.4 Display .....	52
5.8.5 Sensor.....	52
5.9 Advanced.....	53
5.10 Service .....	54
6. LCD Menu Function for MU Series.....	55
6.1 Enter the Main Menu.....	55
6.2 Main Menu Overview .....	55
6.3 Setup.....	56
6.3.1 Printer Setup (TSPL2/ ZPL2).....	56
6.3.2 Sensor.....	61
6.3.3 Serial Comm.....	62
6.3.4 Date Time.....	62
6.4 File Manager .....	63
6.5 Diagnostics .....	64
6.5.1 Print Config.....	64

<b>6.5.2 Dump Mode</b> .....	66
<b>6.5.3 Rotate Cutter</b> .....	67
6.6 Language .....	68
6.7 Service .....	69
7. Diagnostic Tool.....	70
7.1 Start the Diagnostic Tool .....	70
7.2 Printer Function .....	71
7.3 Setting Ethernet by Diagnostic Tool .....	72
<b>7.3.1 Using USB interface to setup Ethernet interface</b> .....	72
<b>7.3.2 Using RS-232 interface to setup Ethernet interface</b> .....	73
<b>6.3.3 Using Ethernet interface to setup Ethernet interface</b> .....	74
8. Troubleshooting.....	76
9. Maintenance.....	79
Revise History .....	80

# 1. Introduction

---

## 1.1 Product Introduction

Thank you very much for purchasing an Altec label printer.

This printer is designed with die-casting aluminum chassis and print mechanism, metal cover with large clear media view window, which ensuring to work for the extreme and heavy duty industrial environment and applications.

With back-lit graphic LCD display, printer status can be managed easier and operated more user friendly. The moveable sensor design can accept wide range of label media. All of the most frequently used bar code formats are included. Fonts and bar codes can be printed in any one of the four directions.

This printer is built-in the high quality, high performance MONOTYPE IMAGING® True Type font engine and one CG Triumvirate Bold Condensed smooth font. With flexible firmware design, user can also download the True Type Font from PC into printer memory for printing labels. Besides the scalable font, it also provides a choice of five different sizes of alphanumeric bitmap font, OCR-A and OCR-B fonts. By integrating rich features, it is the most cost-effective and high performance printer in its class!

- Applications
  - Industrial-duty printing
  - Healthcare patient safety
  - Compliance labeling
  - Work in process
  - Order fulfillment
  - Distribution
  - Shipping/ receiving
  - Ticketing
  - Electronics & jewelry labeling



## 1.2 Product Features

### 1.2.1 Printer Standard Features

The printer offers the following standard features.

Product standard feature	203 dpi models	300 dpi models	600 dpi models
Thermal transfer/ or direct thermal	<input type="radio"/>	<input type="radio"/>	<input type="radio"/>
High quality die-cast aluminum design	<input type="radio"/>	<input type="radio"/>	<input type="radio"/>
Metal cover with large clear media view window	<input type="radio"/>	<input type="radio"/>	<input type="radio"/>
Moveable gap sensor (position adjustable)	<input type="radio"/>	<input type="radio"/>	<input type="radio"/>
Moveable black mark sensor (position adjustable)	<input type="radio"/>	<input type="radio"/>	<input type="radio"/>
Ribbon end sensor	<input type="radio"/>	<input type="radio"/>	<input type="radio"/>
Ribbon encoder sensor (Support color ribbon)	<input type="radio"/>	<input type="radio"/>	<input type="radio"/>
Head open sensor	<input type="radio"/>	<input type="radio"/>	<input type="radio"/>
<ul style="list-style-type: none"> <li>■ Graphic type, 128 x 64 pixel, with back light---MU series</li> <li>■ Resistive Touch Screen, 16 bits Color, 480 x 272 pixels, with back lights---MT series</li> </ul> Supported languages: <ul style="list-style-type: none"> <li>▪ English</li> <li>▪ French</li> <li>▪ German</li> <li>▪ Spanish</li> <li>▪ Italian</li> <li>▪ Traditional Chinese</li> <li>▪ Simplified Chinese</li> <li>▪ Japanese</li> <li>▪ Russian</li> <li>▪ Polish</li> </ul>	<input type="radio"/>	<input type="radio"/>	<input type="radio"/>
Control panel with 6 operation buttons	<input type="radio"/>	<input type="radio"/>	<input type="radio"/>
Control panel security (TCF)	<input type="radio"/>	<input type="radio"/>	<input type="radio"/>
LED indicators	<input type="radio"/>	<input type="radio"/>	<input type="radio"/>
Real time clock	<input type="radio"/>	<input type="radio"/>	<input type="radio"/>
Internal Ethernet print server (10/100 Mbps) interface	<input type="radio"/>	<input type="radio"/>	<input type="radio"/>
USB 2.0 client (High speed mode)	<input type="radio"/>	<input type="radio"/>	<input type="radio"/>
Serial RS-232C (2400-115200 bps) interface	<input type="radio"/>	<input type="radio"/>	<input type="radio"/>
USB host interface, for scanner or PC keyboard	<input type="radio"/>	<input type="radio"/>	<input type="radio"/>
128 MB DDR2 SDRAM memory	<input type="radio"/>	<input type="radio"/>	<input type="radio"/>
128 MB FLASH memory	<input type="radio"/>	<input type="radio"/>	<input type="radio"/>
SD FLASH card memory expands storage to 32 GB	<input type="radio"/>	<input type="radio"/>	<input type="radio"/>
32-bit RISC high performance processor	<input type="radio"/>	<input type="radio"/>	<input type="radio"/>
Standard industry emulations right out of the box including Eltron® and Zebra® language support	<input type="radio"/>	<input type="radio"/>	<input type="radio"/>
Internal 8 alpha-numeric bitmap fonts	<input type="radio"/>	<input type="radio"/>	<input type="radio"/>
Fonts and bar codes can be printed in any one of the four directions (0, 90,180, 270 degree)	<input type="radio"/>	<input type="radio"/>	<input type="radio"/>
Internal Monotype Imaging® true type font engine with one CG Triumvirate Bold Condensed scalable font	<input type="radio"/>	<input type="radio"/>	<input type="radio"/>
Downloadable fonts from PC to printer memory	<input type="radio"/>	<input type="radio"/>	<input type="radio"/>

Bar code, graphics/image printing													
<table border="1"> <thead> <tr> <th colspan="2">Supported bar code</th> <th>Supported image</th> </tr> <tr> <th>1D bar code</th> <th>2D bar code</th> <th></th> </tr> </thead> <tbody> <tr> <td>Code128 subsets A.B.C, Code128UCC, EAN128, Interleave 2 of 5, Code 39, Code 93, EAN-13, EAN-8, Codabar, POSTNET, UPC-A, UPC-E, EAN and UPC 2(5) digits, MSI, PLESSEY, China Post, ITF14, EAN14, Code 11, TELPEN, PLANET, Code 49, Deutsche Post Identcode, Deutsche Post Leitcode, LOGMARS</td> <td>CODABLOCK F mode, DataMatrix, Maxicode, PDF- 417, Aztec, MicroPDF417, QR code, RSS Barcode (GS1 Databar)</td> <td>BITMAP, BMP, PCX (Max. 256 colors graphics)</td> </tr> </tbody> </table>		Supported bar code		Supported image	1D bar code	2D bar code		Code128 subsets A.B.C, Code128UCC, EAN128, Interleave 2 of 5, Code 39, Code 93, EAN-13, EAN-8, Codabar, POSTNET, UPC-A, UPC-E, EAN and UPC 2(5) digits, MSI, PLESSEY, China Post, ITF14, EAN14, Code 11, TELPEN, PLANET, Code 49, Deutsche Post Identcode, Deutsche Post Leitcode, LOGMARS	CODABLOCK F mode, DataMatrix, Maxicode, PDF- 417, Aztec, MicroPDF417, QR code, RSS Barcode (GS1 Databar)	BITMAP, BMP, PCX (Max. 256 colors graphics)	○	○	○
Supported bar code		Supported image											
1D bar code	2D bar code												
Code128 subsets A.B.C, Code128UCC, EAN128, Interleave 2 of 5, Code 39, Code 93, EAN-13, EAN-8, Codabar, POSTNET, UPC-A, UPC-E, EAN and UPC 2(5) digits, MSI, PLESSEY, China Post, ITF14, EAN14, Code 11, TELPEN, PLANET, Code 49, Deutsche Post Identcode, Deutsche Post Leitcode, LOGMARS	CODABLOCK F mode, DataMatrix, Maxicode, PDF- 417, Aztec, MicroPDF417, QR code, RSS Barcode (GS1 Databar)	BITMAP, BMP, PCX (Max. 256 colors graphics)											
Supported code page:													
<ul style="list-style-type: none"> <li>▪ Codepage 437 (English - US)</li> <li>▪ Codepage 737 (Greek)</li> <li>▪ Codepage 850 (Latin-1)</li> <li>▪ Codepage 852 (Latin-2)</li> <li>▪ Codepage 855 (Cyrillic)</li> <li>▪ Codepage 857 (Turkish)</li> <li>▪ Codepage 860 (Portuguese)</li> <li>▪ Codepage 861 (Icelandic)</li> <li>▪ Codepage 862 (Hebrew)</li> <li>▪ Codepage 863 (French Canadian)</li> <li>▪ Codepage 864 (Arabic)</li> <li>▪ Codepage 865 (Nordic)</li> <li>▪ Codepage 866 (Russian)</li> <li>▪ Codepage 869 (Greek 2)</li> <li>▪ Codepage 950 (Traditional Chinese)</li> <li>▪ Codepage 936 (Simplified Chinese)</li> <li>▪ Codepage 932 (Japanese)</li> <li>▪ Codepage 949 (Korean)</li> <li>▪ Codepage 1250 (Latin-2)</li> <li>▪ Codepage 1251 (Cyrillic)</li> <li>▪ Codepage 1252 (Latin-1)</li> <li>▪ Codepage 1253 (Greek)</li> <li>▪ Codepage 1254 (Turkish)</li> <li>▪ Codepage 1255 (Hebrew)</li> <li>▪ Codepage 1256 (Arabic)</li> <li>▪ Codepage 1257 (Baltic)</li> <li>▪ Codepage 1258 (Vietnam)</li> <li>▪ ISO-8859-1: Latin-1 (Western European)</li> <li>▪ ISO-8859-2: Latin-2 (Central European)</li> <li>▪ ISO-8859-3: Latin-3 (South European)</li> <li>▪ ISO-8859-4: Latin-4 (North European)</li> <li>▪ ISO-8859-5: Cyrillic</li> <li>▪ ISO-8859-6: Arabic</li> <li>▪ ISO-8859-7: Greek</li> <li>▪ ISO-8859-8: Hebrew</li> <li>▪ ISO-8859-9: Turkish</li> <li>▪ ISO-8859-10: Nordic</li> </ul>		○	○	○									

<ul style="list-style-type: none"> <li>• ISO-8859-15: Latin-9</li> <li>• UTF-8</li> </ul>			
---	--	--	--

### 1.2.2 Printer Optional Features

The printer offers the following optional features.

Product option feature	User option	Dealer option	Factory option
Applicator I/O interface (GPIO)			○
Main board with extended memory ( 512 MB Flash/ 256 MB SDRAM )			○
Peel-off kit (Include liner rewind spindle and peel off sensor)		○	
Internal rewind kit (Max. 6" OD/ Include label rewind spindle and label redirect kit)		○	
Regular guillotine cutter (Cut on non-adhesive material) 0.06~0.25 mm thickness	○		
Rotary heavy duty cutter paper weight <200g/m <sup>2</sup>	○		
Care label cutter Media width: 25.4~70 mm Media thickness: Max. 0.15 mm Media core ID: 50.8 mm~76.2 mm Non-print area: 2mm from top of form	○		
KP-200 Plus series keyboard	○		
KU-007 Plus programmable smart keyboard	○		
Bluetooth module (Serial interface)	○		
802.11 b/g/n wireless module (Serial interface)	○		

**Note: Except for the linerless cutter, all regular/heavy duty/care label cutters DO NOT cut on media with glue.**

### 1.3 General Specifications

General Specifications	
Physical dimensions	270 mm (W) x 308 mm (H) x 515 mm (D)
Weight	15 kg (33.07 lbs)
Power	Internal switching power supply Input: AC 100-240V, 2A, 50-60Hz Output: DC 24V, 5A, 120W
Environmental condition	Operation: 5 ~ 40°C (41 ~ 104°F), 25~85% non-condensing Storage: -40 ~ 60 °C (-40 ~ 140°F), 10~90% non-condensing
Environmental concern	Comply with RoHS, WEEE

### 1.4 Print Specifications

Print Specifications	203 dpi models	300 dpi models	600 dpi models
Print head resolution (dots per inch/mm)	203 dots/inch (8 dots/mm)	300 dots/inch (12 dots/mm)	600 dots/inch (24 dots/mm)
Printing method	Thermal transfer/ or direct thermal		
Dot size (width x length)	0.125 x 0.125 mm (1 mm = 8 dots)	0.084 x 0.084 mm (1 mm = 12 dots)	0.042 x 0.042 mm (1 mm = 24 dots)
Print speed (inches per second)	Up to 14 ips (11~14 ips for special media)	Up to 10 ips (7-10 ips for special media)	4 ips
Max. print width	4.09" (104 mm)		
Max. print length	1000" (25400 mm)	450" (11430 mm)	100" (2540 mm)
Printout bias	Vertical: 1 mm max. Horizontal: 1 mm max.		
Printing ratio	20%, Full web black bar thickness can't be greater than 48 dots height		

### 1.5 Ribbon Specifications

Ribbon Specifications	
Ribbon outside diameter	Max. 90 mm
Ribbon length	600 meter long
Ribbon core inside diameter	1" core (25.4 mm)
Ribbon width	25.4 mm ~ 113 mm
Ribbon wound type	Ink coated outside or inside
<b>Note: Support color ribbon</b>	

## 1.6 Media Specifications

Media Specifications	203 dpi models	300 dpi models	600 dpi models
Label roll capacity	208.3 mm (8.2") OD		
Media alignment	Edge alignment		
Media type	Continuous, die-cut, Fan-fold, tag, notched, black mark, perforated, care label (width less than 3 inch)		
Media wound type	Printing face outside wound		
Media width	25.4~116mm (1" ~ 4.5")		
Media thickness	0.06~0.30 mm (2.3~11.8 mil), max. 300g/m <sup>2</sup>		
Media core diameter	25.4~76.2 mm (1"~3")		
Label length	5~25400 mm (0.20"~1000")	5~11,430mm (0.20"~450")	5~2540mm (0.20"~100")
Label length (cutter mode)	25.4~4064 mm (1"~ 160")	25.4~1854 mm (1"~73")	25.4~1016 mm (1"~40")
Label length (peeler mode)	25.4~152.4 mm (1"~6")		
Gap height	Min. 2 mm		
Black mark height	Min. 2 mm		
Black mark width	Min. 8 mm (0.31")		

## 2. Operations Overview

---

### 2.1 Unpacking and Inspection

This printer has been specially packaged to withstand damage during shipping. Please carefully inspect the packaging and printer upon receiving the bar code printer. Please retain the packaging materials in case you need to reship the printer. Unpacking the printer, the following items are included in the carton.

- One printer unit
- One Windows labeling software/Windows driver CD disk
- One quick installation guide
- One power cord
- One USB interface cable

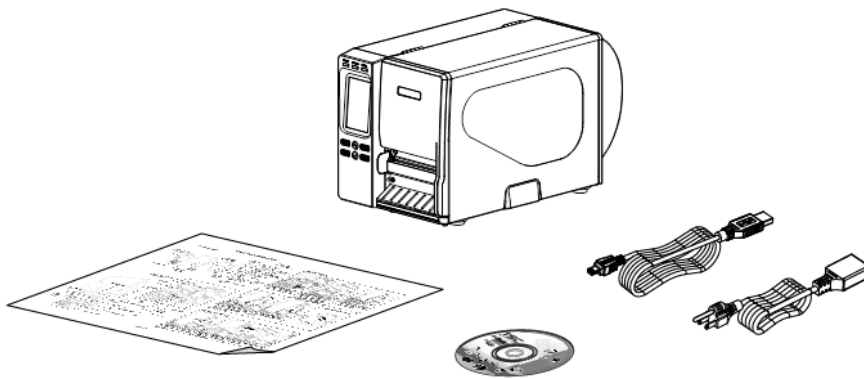

If any parts are missing, please contact the Customer Service Department of your purchased reseller or distributor.

# 2.2 Printer Overview

## 2.2.1 Front View

For MU series



For MT series



1. LED indicators
2. Touch screen
3. Operation buttons
4. Media view window
5. Paper exit chute
6. Printer cover



## 2.2.2 Interior view

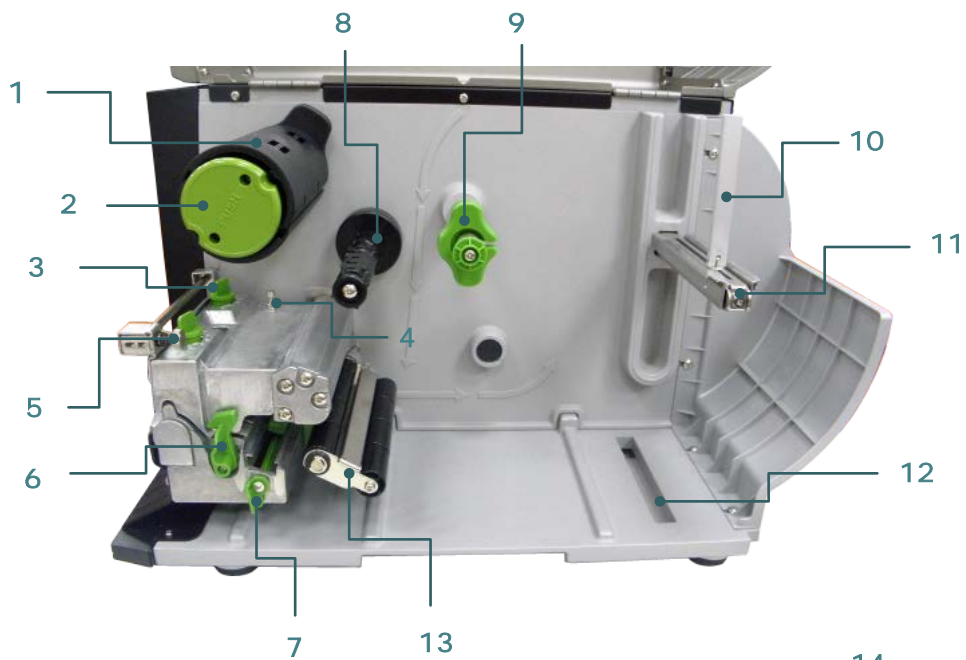

1. Ribbon rewind spindle
2. Ribbon release button
3. Print head pressure adjustment knobs
4. Z axis mechanism adjustment knob
5. Ribbon tension adjustment knob
6. Print head release lever
7. Media sensor lock lever
8. Ribbon supply spindle
9. Media guide bar & Rear label guide
10. Label roll guard
11. 3" label supply spindle
12. External label entrance chute
13. Damper

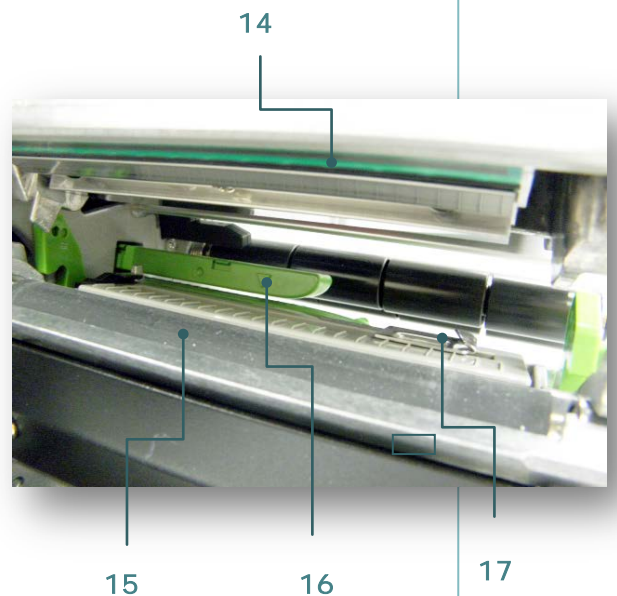

### 2.2.3 Rear View

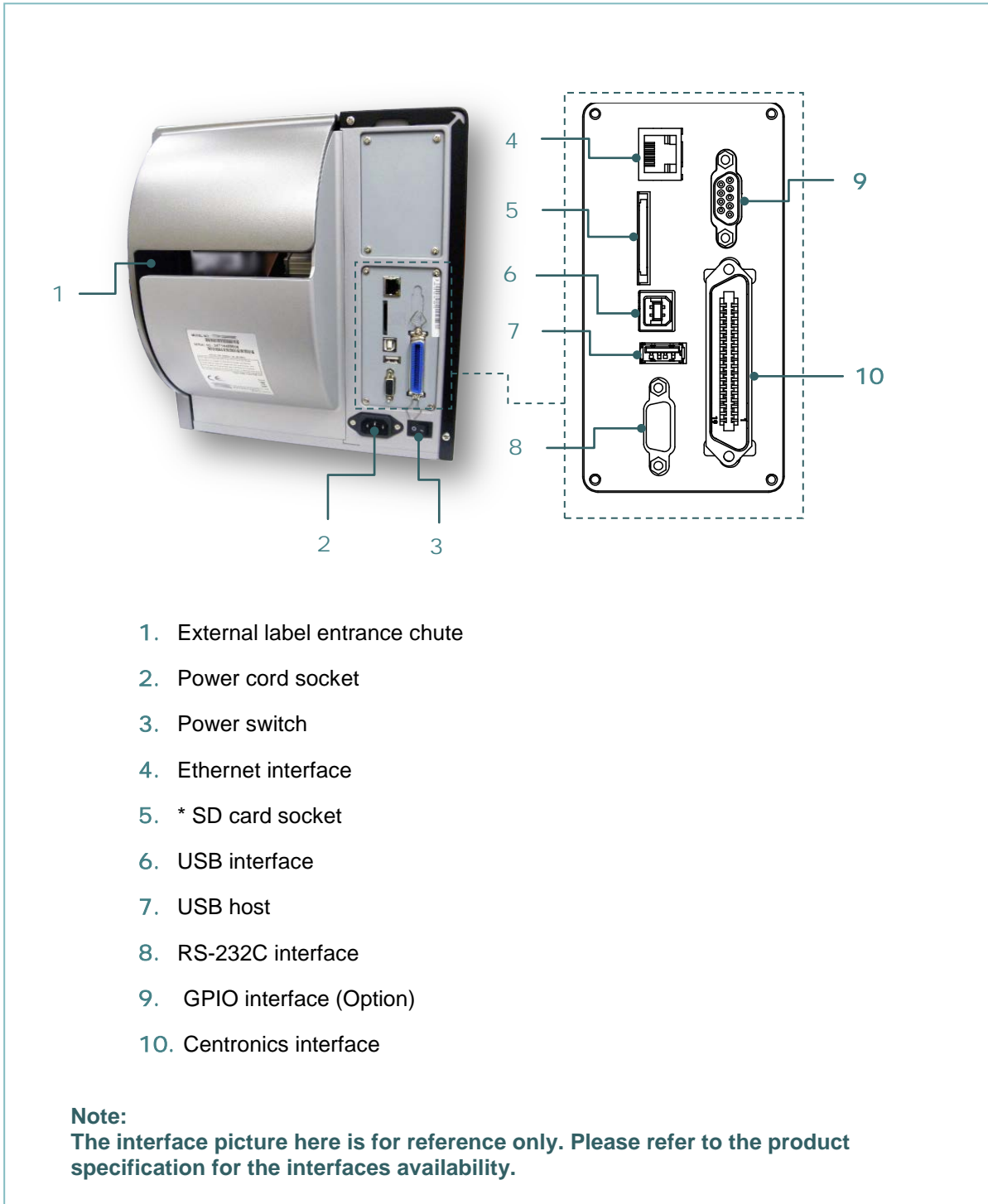

**\* Recommended SD card specification**

Type	SD card spec	SD card capacity	Approved SD card manufacturer
SDHC	V2.0 Class 4	2G	Transcend
	V3.0 Class 10	32G	Kingston
	V3.0 Class 10	16G	Kingston
	V2.0 Class 4	8G	Scandisk
	V3.0 Class 10	32G	Scandisk

Micro SD	V2.0 Class 4	4G	Transcend
	V2.0 Class 4	8G	Transcend
	V3.0 Class 10 UHS-I	16G	Transcend
	V3.0 Class 10 UHS-I	32G	Transcend
	V3.0 Class 10	16G	Kingston
	V2.0 Class 4	16G	Scandisk
	V3.0 Class 10 UHS-I	16G	Scandisk
<ul style="list-style-type: none"> <li>- The DOS FAT file system is supported for the SD card.</li> <li>- Folders/files stored in the SD card should be in the 8.3 filename format.</li> <li>- The miniSD/microSD card to SD card slot adapter is required.</li> </ul>			

## 2.3 Operator Control

For MU series

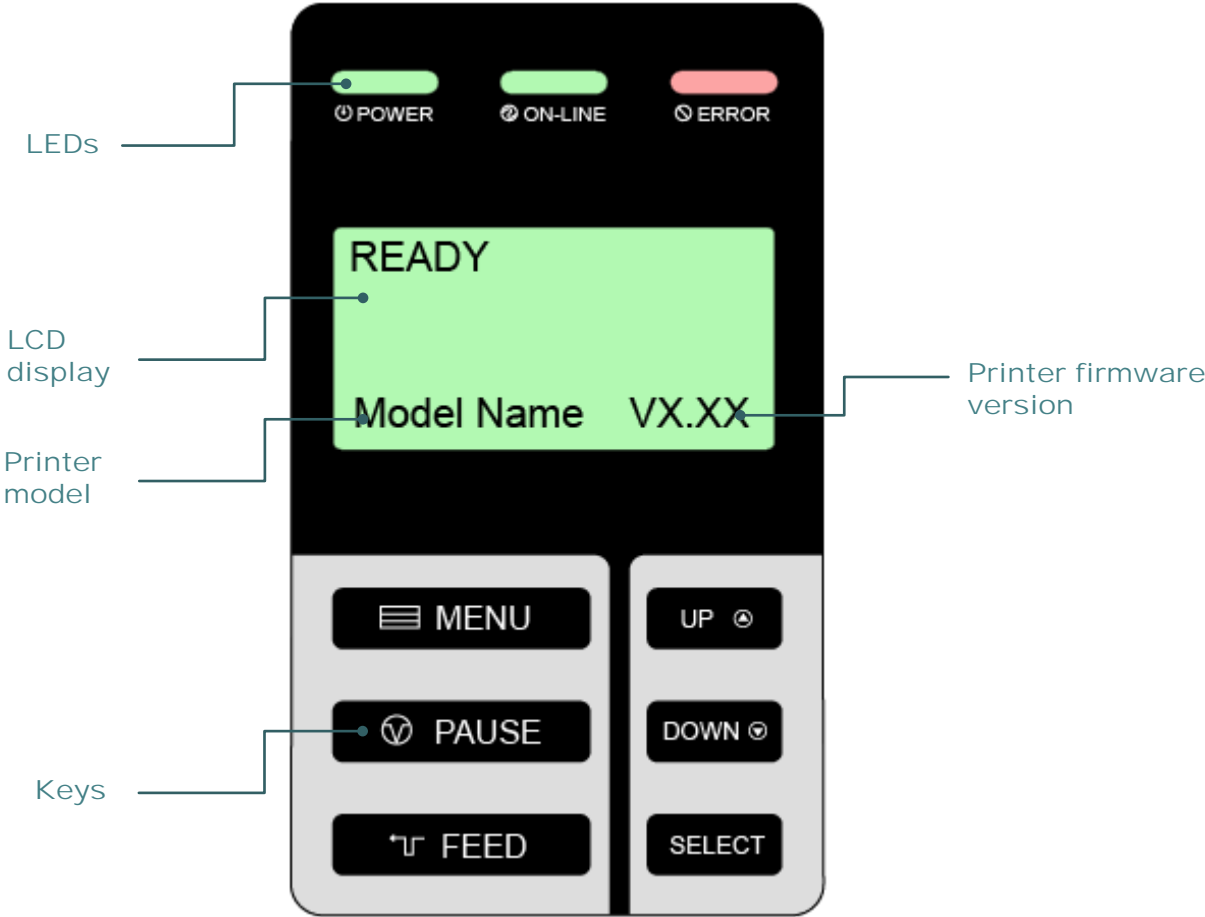

For MT series

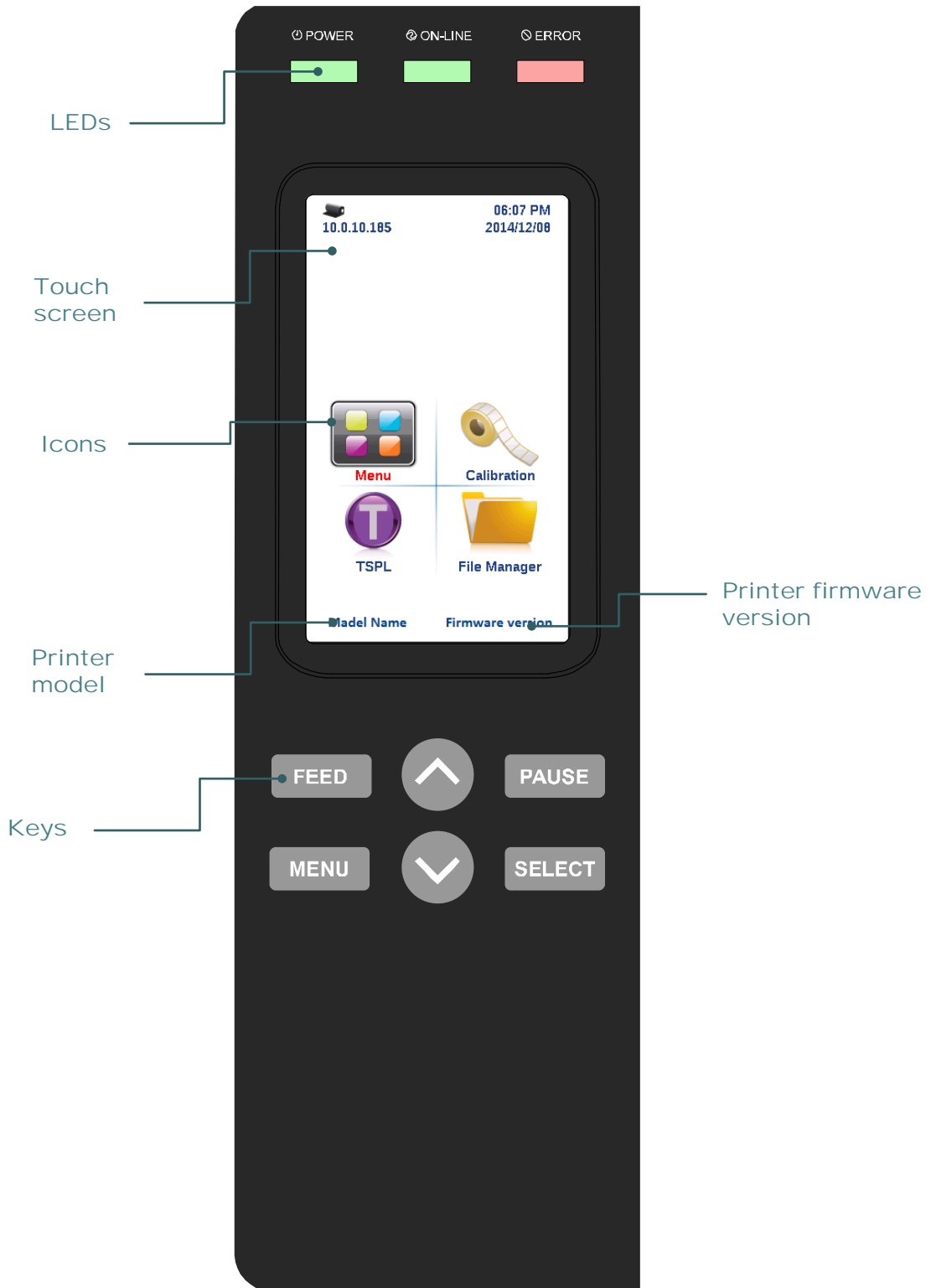

### 2.3.1 LED Indication and Keys

LED	Status	Indication
<b>POWER</b>	Off	Printer power off
	On	Printer power on
<b>ON-LINE</b>	On	Printer is ready
	Blinking	Printer is paused
		Printer is downloading data
<b>ERROR</b>	Off	Printer is ready
	On	Carriage open or cutter error
	Blinking	No paper, paper jam or no ribbon
Keys	Function	
<b>PAUSE</b>	Pause/Resume the printing process	
<b>MENU</b>	1. Enter the menu 2. Exit from a menu or cancel a setting and return to the previous menu	
<b>FEED</b>	Advances one label	
<b>UP</b>	Scroll up the menu list	
<b>SELECT</b>	Enter/Select cursor located option	
<b>DOWN</b>	Scroll down the menu list	

### 2.3.2 Touch Screen (MT series)

Tap an item to open/use it.

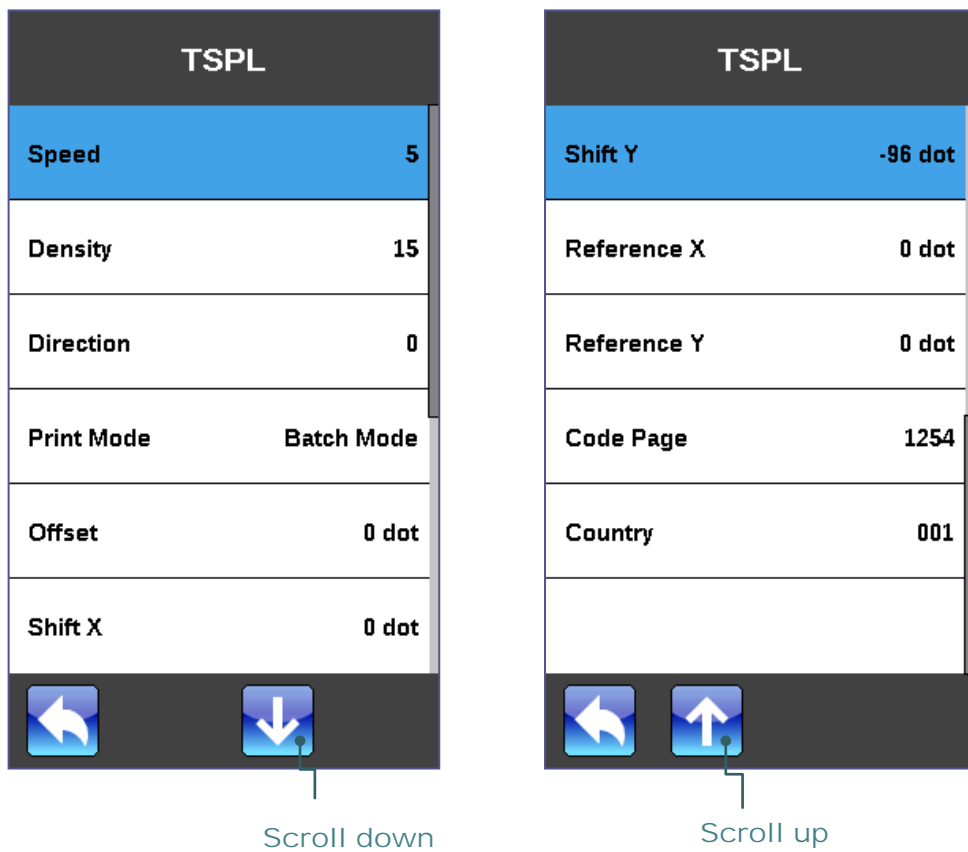
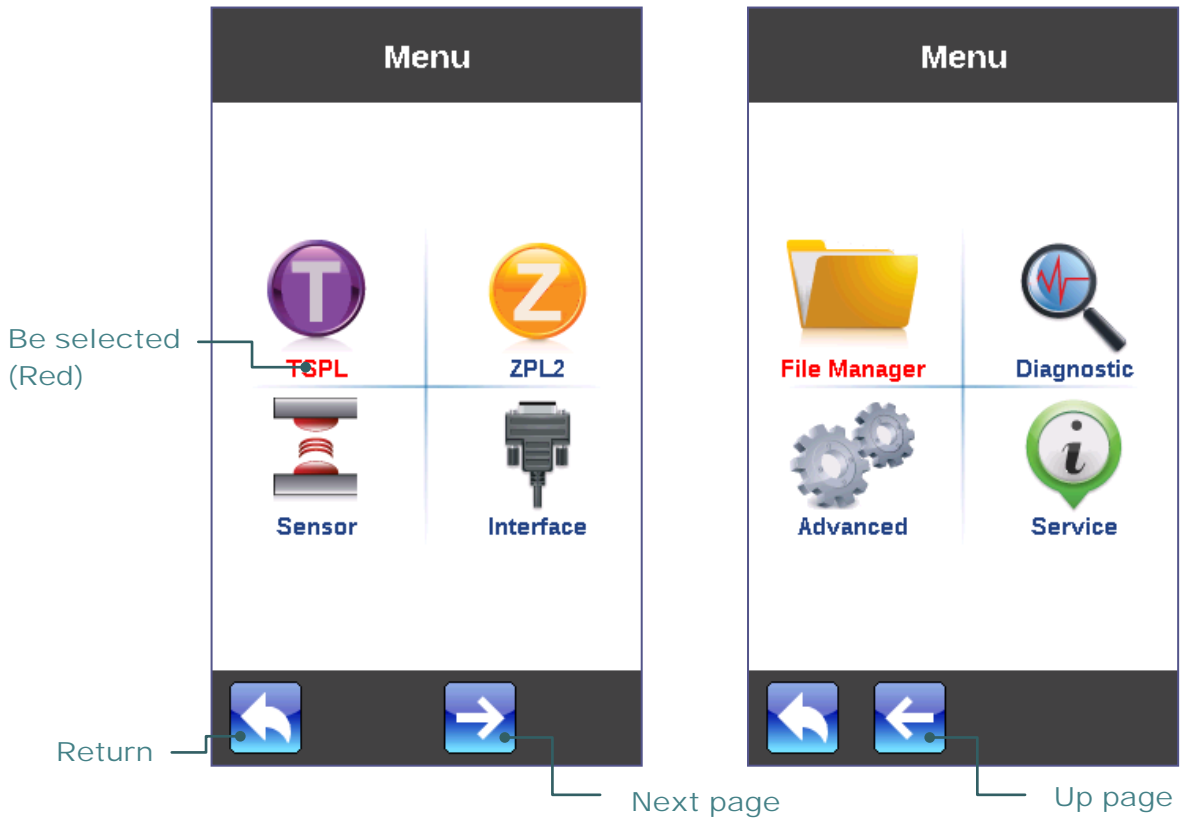

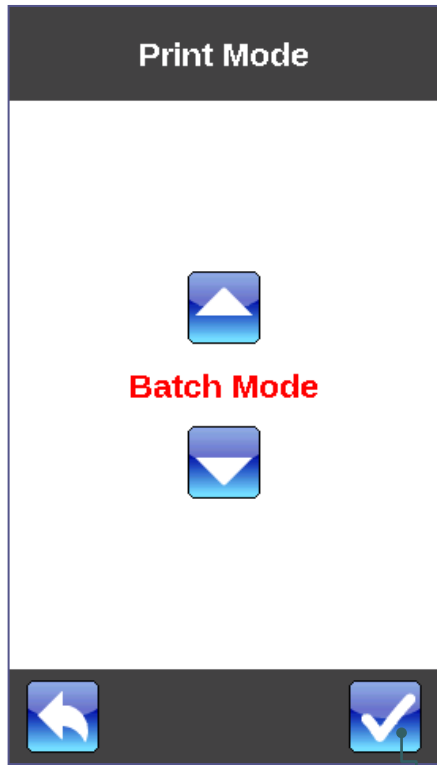

Set

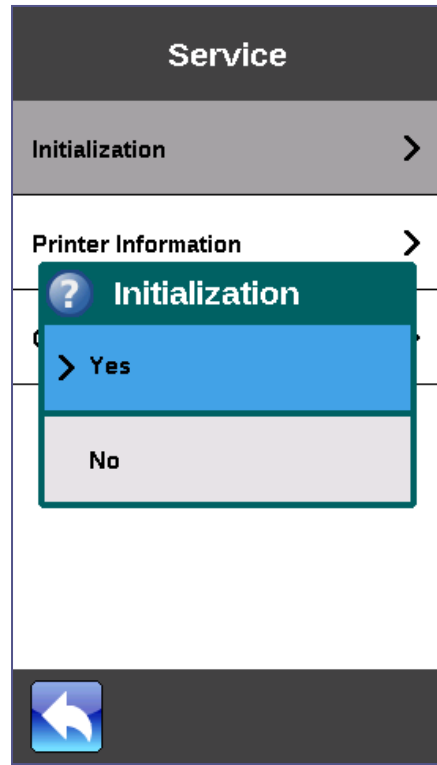



## 3. Setup

---

### 3.1 Setting up the printer

1. Place the printer on a flat, secure surface.
2. Make sure the power switch is off.
3. Connect the printer to the computer with the provided USB cable.
4. Plug the power cord into the AC power cord socket at the rear of the printer, and then plug the power cord into a properly grounded power outlet.

**Note: Please switch OFF printer power switch prior to plug in the power cord to printer power jack.**

## 3.2 Loading the Ribbon

### 3.2.1 Loading the Ribbon



1. Open the printer right side cover.

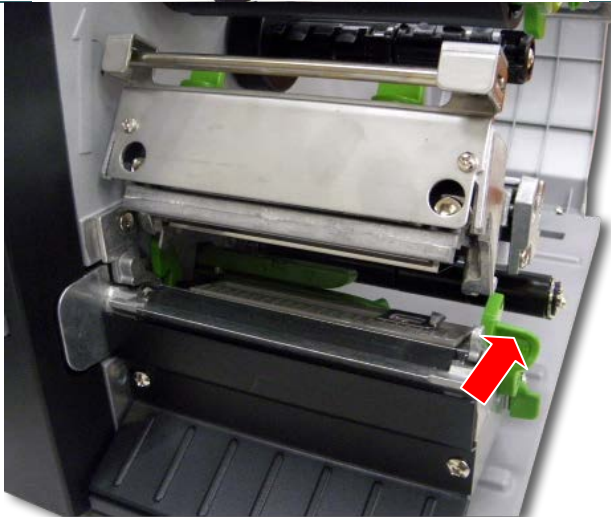

2. Push the print head release lever to open the print head mechanism.

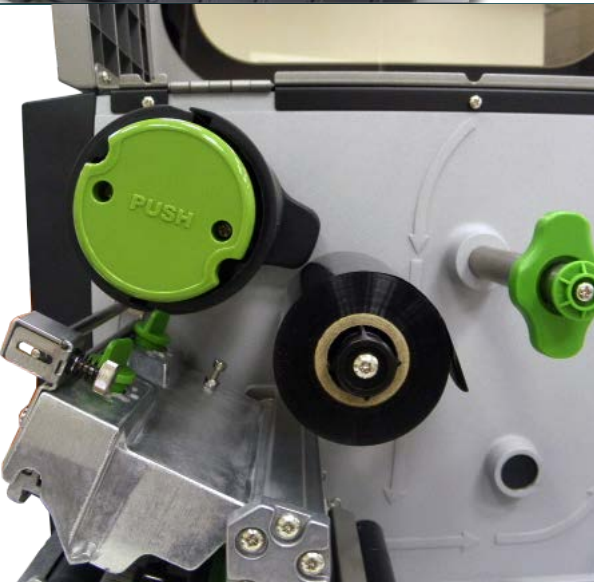

3. Install the ribbon onto ribbon supply spindle.

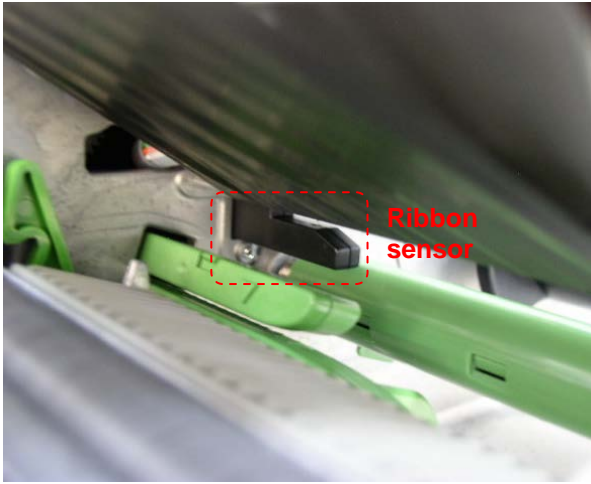

4. Thread the ribbon through the ribbon sensor slot and then through the open space in between print head and platen.

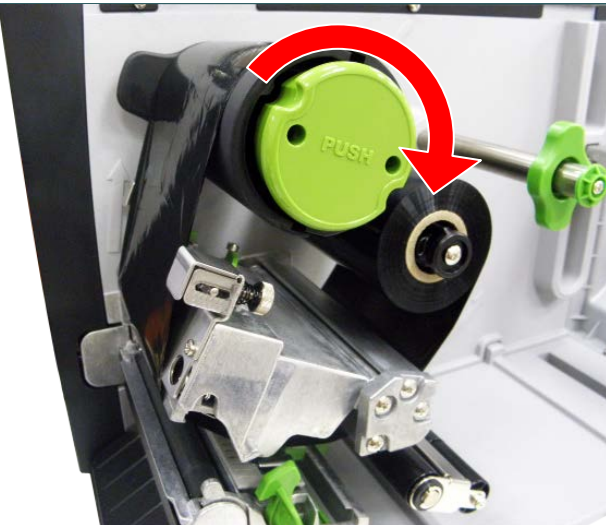

5. Wrap the ribbon onto the ribbon rewind spindle. Wind the ribbon clockwise about 3~5 circles onto the ribbon rewind spindle until it is smooth and properly stretched.

*Note: Please **DO NOT** push the ribbon release button when you are loading the ribbon. The ribbon release button is used to remove the used ribbon.*

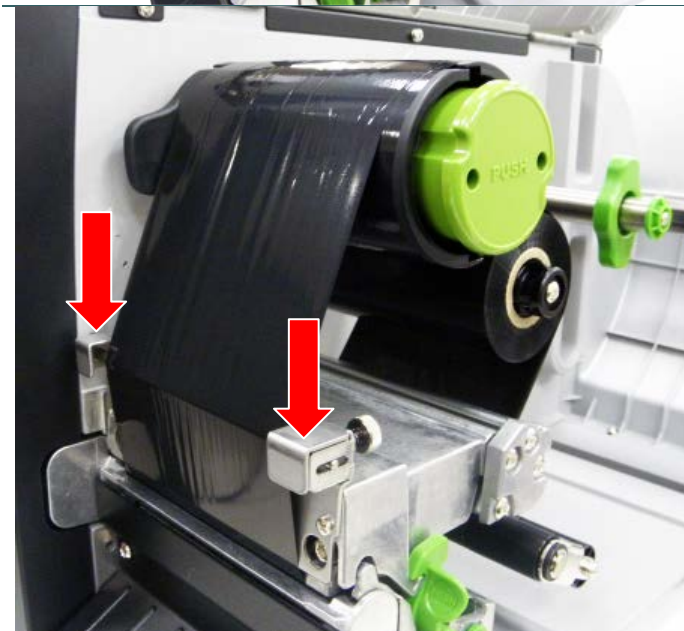

6. Close the print head mechanism, Make sure the latches are engaged securely.

---

## Loading path for ribbon

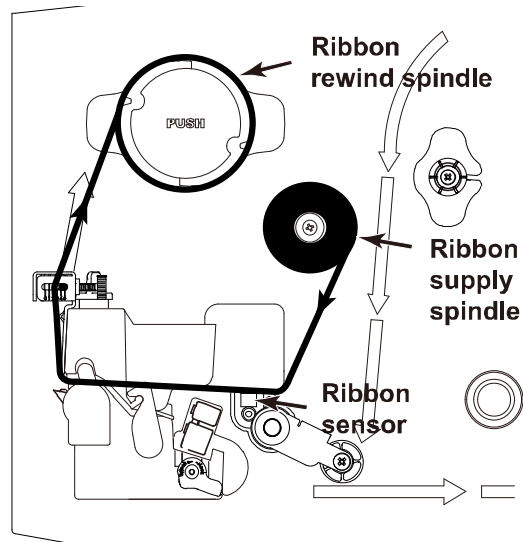

### 3.2.2 Remove Used Ribbon



1. Break the ribbon between ribbon guide plate and the ribbon rewind spindle.



2. Push the ribbon release button to release the ribbon on the ribbon rewind spindle.



3. Slide off the ribbon from ribbon rewind spindle.

## 3.3 Loading the Media

### 3.3.1 Loading the Media



1. Open the printer right side cover.

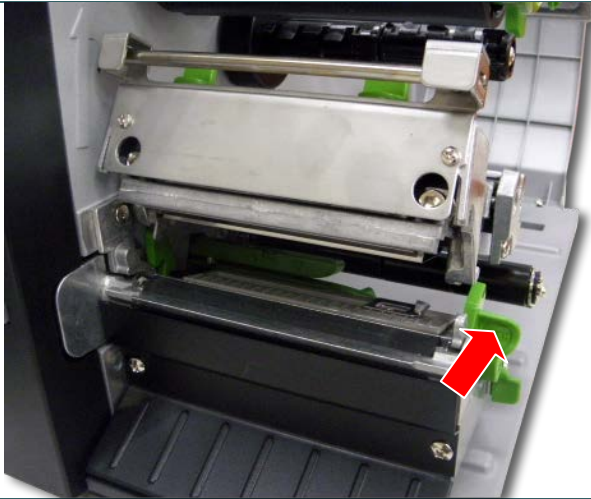

2. Push the print head release lever to open the print head mechanism.

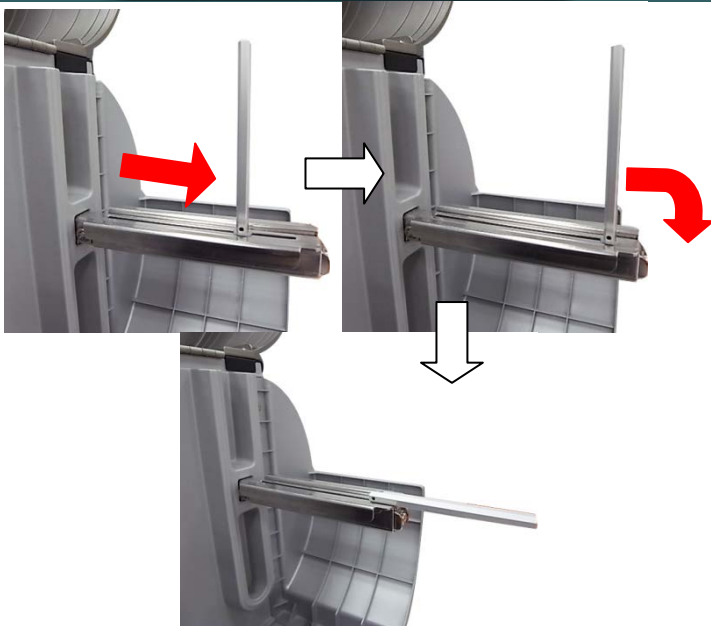

3. Move the label roll guard horizontally to the end of label spindle then flip down the label roll guard.

- 
- Place the roll of media on the label supply spindle. Flip up the label roll guard. Move the label roll guard horizontally to gently fit the width of label roll.

**3" core label spindle**



**1" core label spindle**

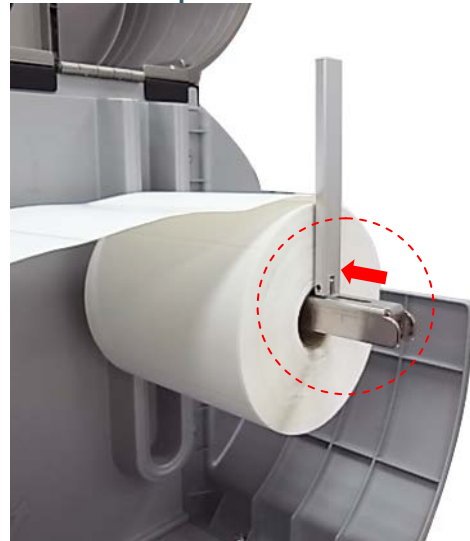

**Replace 3" core label spindle module to fit the 1" core label by removing two screws.**

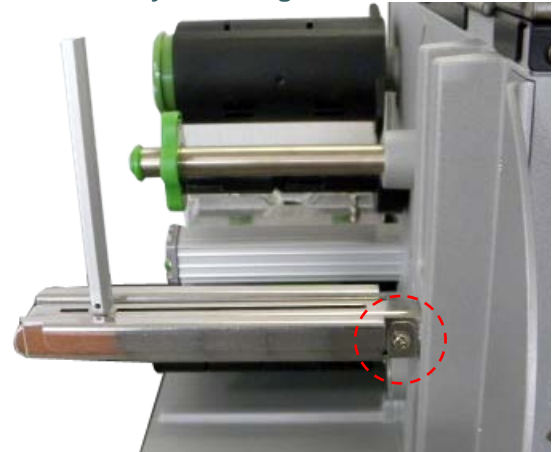

- Pull label roll leading edge forward through the media guide bar, damper, media sensor (green) and place the label leading edge onto the platen roller. Adjust the rear label guide (green) to fit the width of the label.



6. Unlock the media sensor lock lever to adjust the media sensor, make sure the gap or black mark sensor is at the location where media gap/black mark will pass through for sensing.

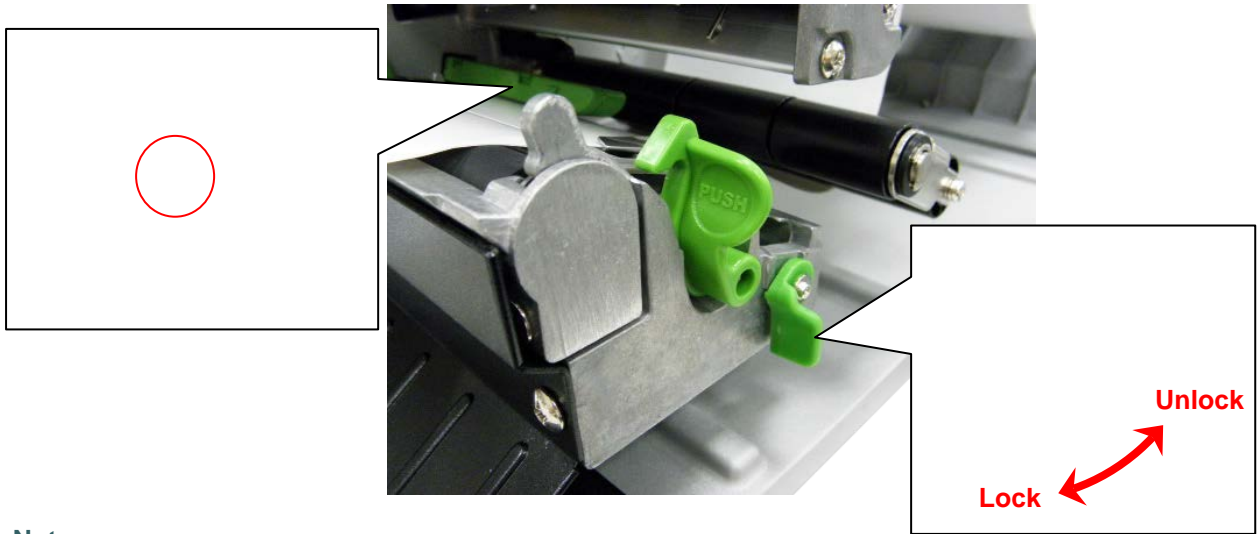

**Note:**

- \* The sensor location is marked by a triangle mark  $\nabla$  at the sensor housing.
- \* The media sensor position is moveable, please make sure the gap or black mark is at the location where media gap/black mark will pass through for sensing.

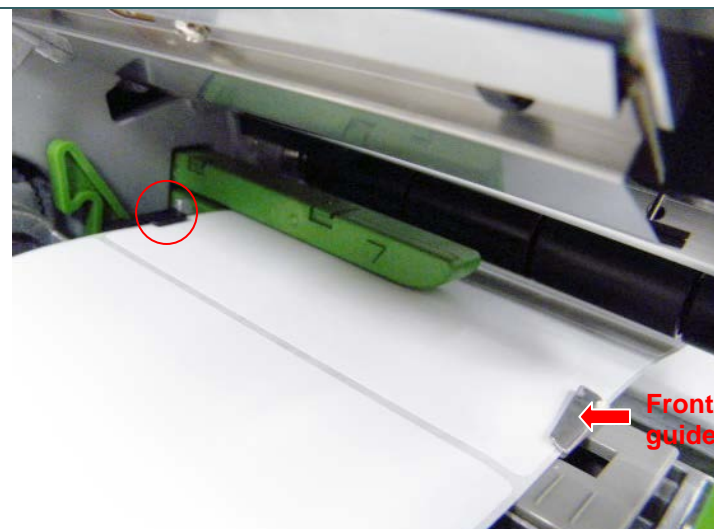

7. Adjust front label guide to fit the width of the label.

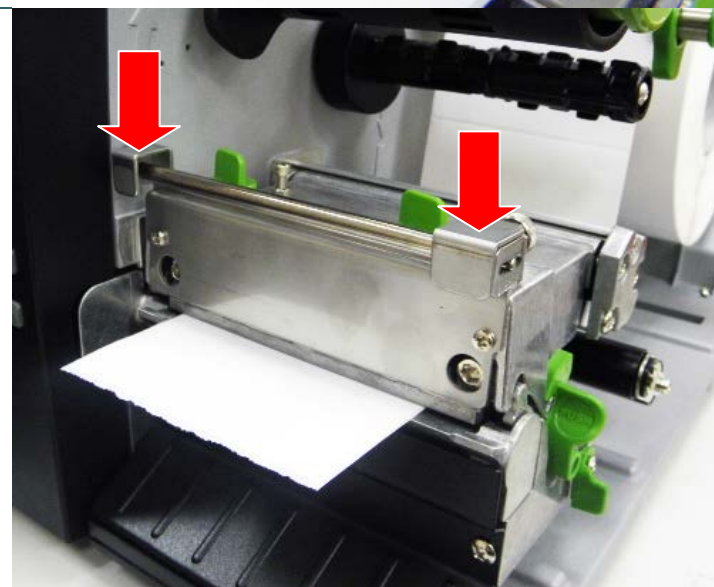

8. Close the print head mechanism. Make sure the latches are engaged securely.
9. Using the front display panel, set media sensor type and calibrate the selected sensor.

**Note:**

- \* Please calibrate the gap/black mark sensor when changing media.



---

## Loading path for media

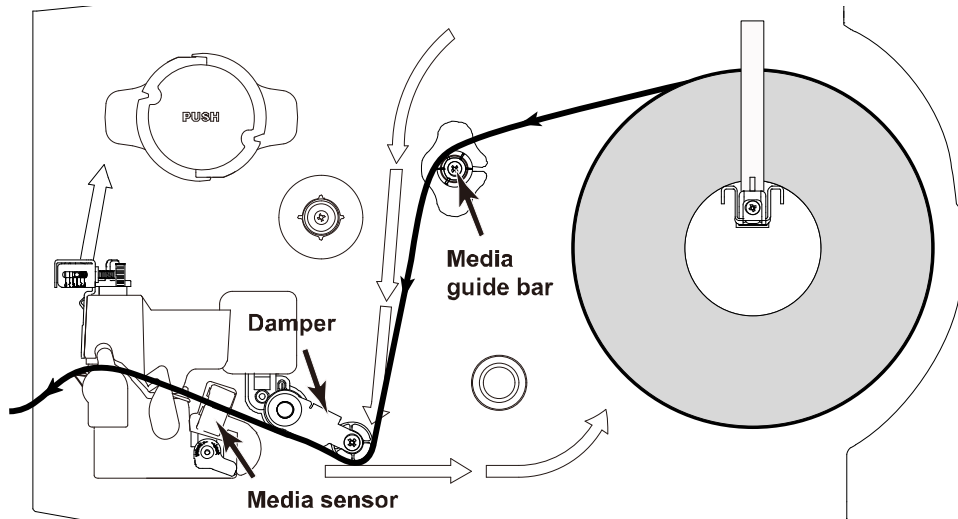

### 3.3.2 Loading the Fan-fold/External Media



1. Open the printer right side cover.
2. Insert the fan-fold media through the bottom or rear external label entrance chute.
3. Please refer to section 3.3.1 to loading media.

**Note:**  
Please calibrate the gap/black mark sensor when changing media.

#### Loading path for fan-fold labels

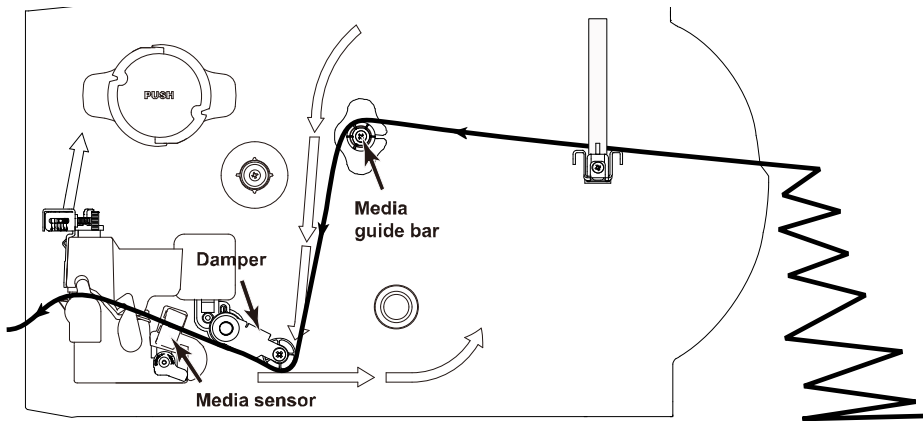

### 3.3.3 Loading Media in Peel-off Mode (Option)



1. Open the printer right side cover.
2. Please refer to section 3.3.1 step 3~9 for loading media.
3. Using the front display panel to do the calibration first and set the printer mode to peeler mode.

**Note:**

**Please calibrate the gap/black mark sensor before loading media in peel-off mode to avoid paper jam.**

4. Open print head release lever to pull approximately 650mm of label through the front of the printer.
5. Push down the peel-off roller release lever.

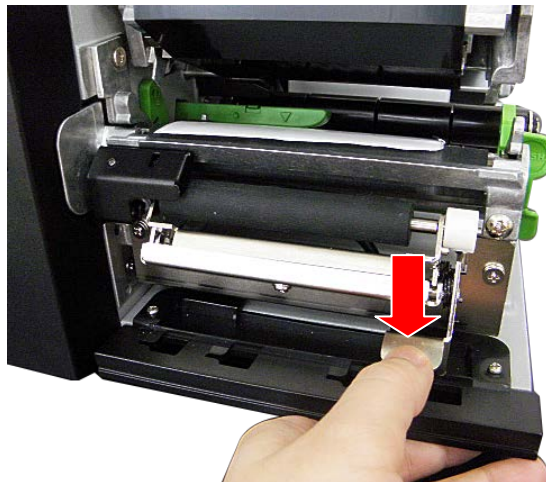

6. Feed the label between peel-off roller and platen roller.

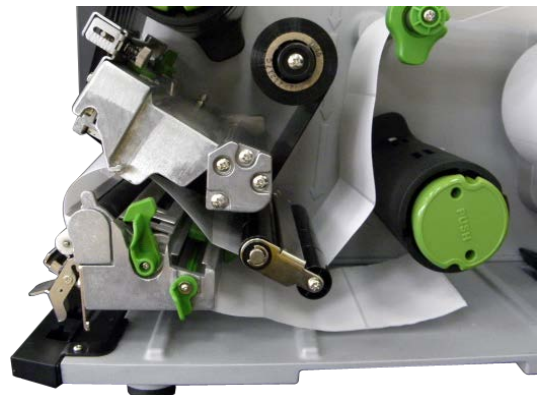

- 
7. Wrap the label onto the internal rewind spindle and wind the spindle counter-clockwise about 3~5 circles until the label is properly stretched.

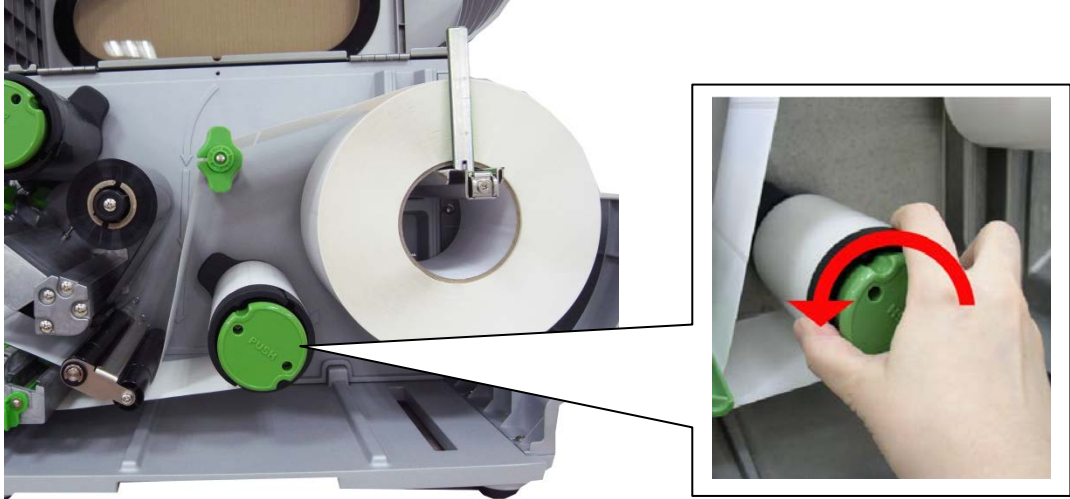

- 
8. Lift up the peel-off roller release lever and close the print head mechanism.

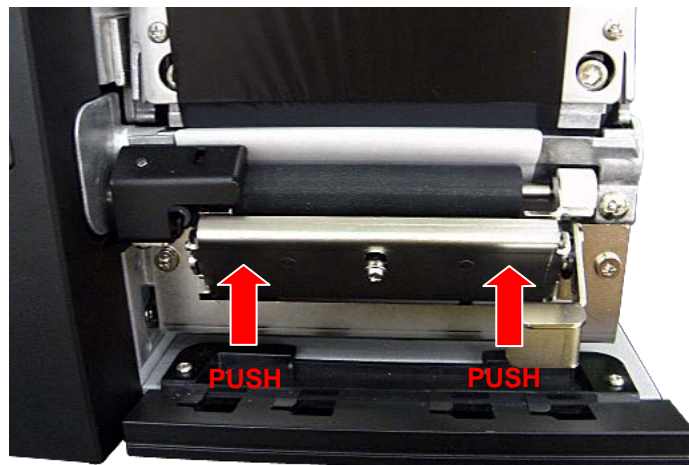

9. Peeling will automatically start. Press the FEED button to test.

### 3.3.4 Remove Liner from Internal Rewind (Option)



1. Break the liner between peel-off roller and the internal rewind spindle.



2. Push the liner release button to release the liner on the internal rewind spindle.



3. Slide off the liner from internal rewind spindle.

### 3.3.5 Loading Media in Rewind Liner with Label Mode (Option)

This mode can rewind the media including liner and label on the rewind spindle

1. Open the printer right side cover and the print head mechanism.
2. Insert the supply holder guide and paper core into the internal rewind for 1" core label roll. Insert the supply holder guide, 3" label core adapter and paper core into the internal rewind for 3" core label roll.

1" core label roll



3" core label roll



3. Insert media into the printer label spindle. Pull label roll leading edge forward through the media guide bar, damper media sensor and place the label leading edge onto the platen roller.
4. Pull approximately 650mm of label through the label redirect front panel.
5. Wrap the label onto the internal rewind spindle and stick the label onto the paper core.

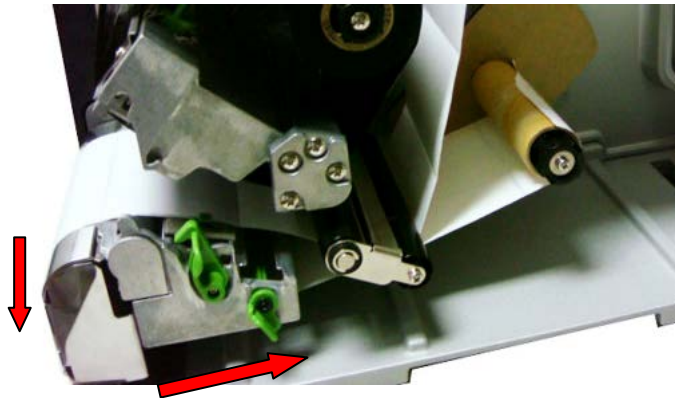

6. Insert another supply holder guide into the internal rewind for 1" core label roll.
7. Close the print head mechanism.
8. Using the LCD panel to set the media sensor type and calibrate the selected sensor.

### 3.3.6 Remove Labels from Internal Rewind (Option)

---

1. Slide off the labels with supply holder guides from internal rewind spindle.



## 4. Adjustment Knob

---

### 4.1 Print Head Pressure Adjustment knob

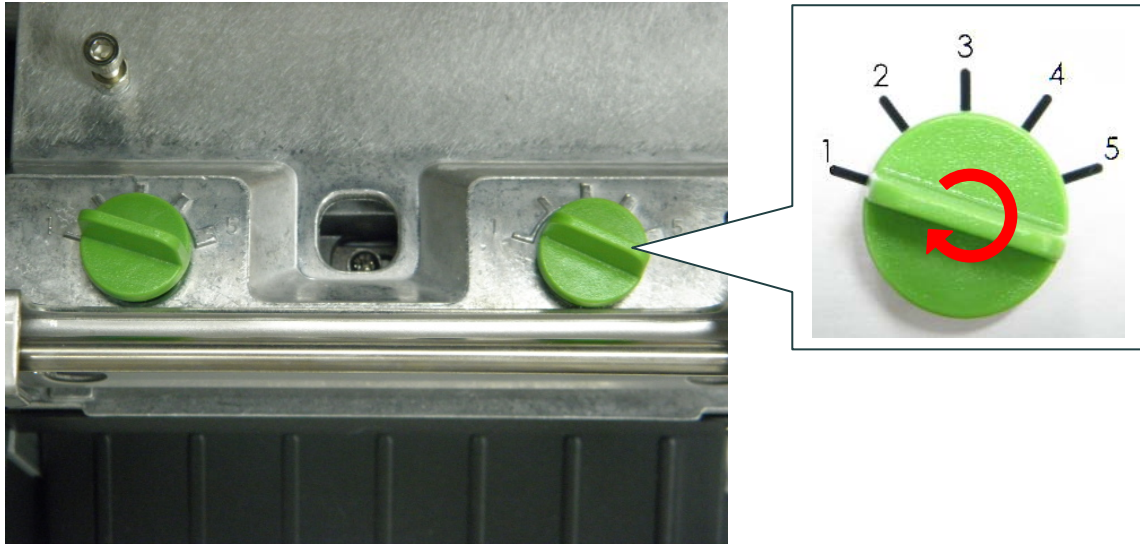

The print head pressure adjustment knob has 5 levels of adjustment. Because the printer's paper alignment is to the left side of mechanism, different media widths require different pressure to print correctly. Therefore it may require to adjust the pressure knob to get your best print quality. For example, if the label width is 4", adjust both print head pressure adjustment knobs to the same level. If the label is less than 2" wide, increase the left side print head pressure by rotating the adjustment knob clockwise and decrease the right side pressure by rotating the adjustment knob counter-clockwise to level 1. Please refer to section 4.4 for more information.



## 4.2 Ribbon Tension Adjustment Module

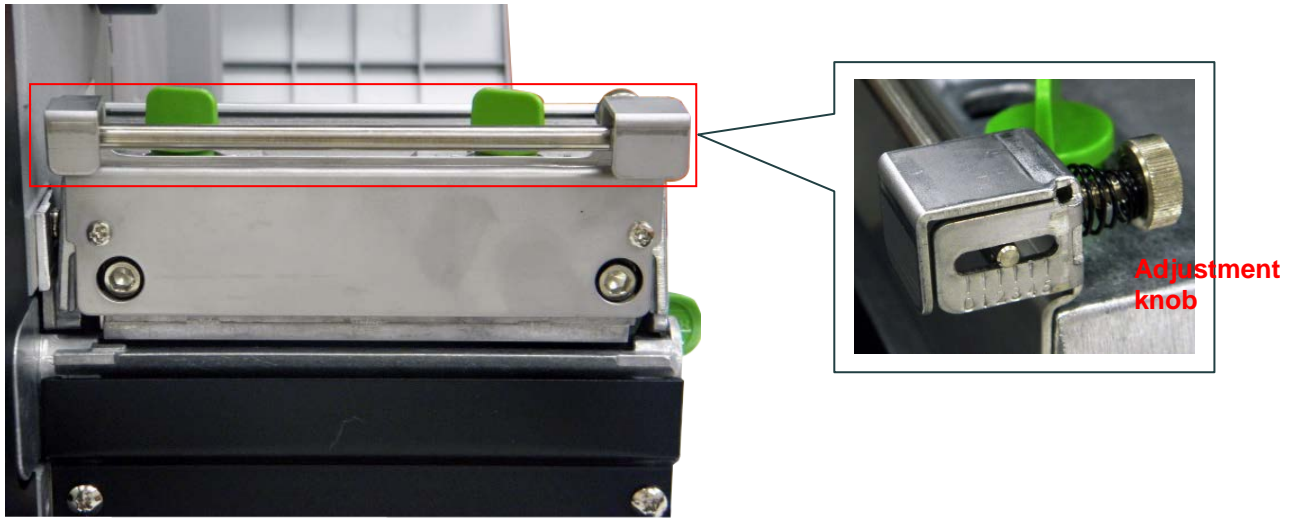

The ribbon tension adjustment knob has 0 ~ 5 positions for adjustment. Because the printer's ribbon alignment is to the left side of mechanism, different ribbon or media widths require different tension to print correctly. Therefore it may require to adjust the ribbon tension knob to get your best print quality. Please refer to section 4.4 for more information.

### 4.3 Print Head Burn Line Adjustment Knob

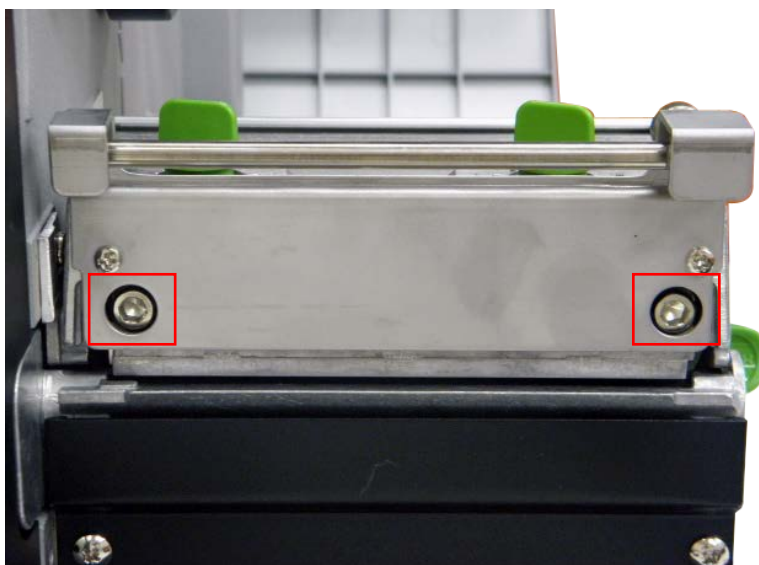

The print head burn line adjustment knobs are used to fine tune the print quality for different thickness of media. Turning the knobs adjusts the print head's burn line forward or backward as it relates to the platen roller.

The print head burn line default is set for general purpose printing media (plain paper and paper thickness less than 0.20mm). In general using, it does not need to adjust the print head burn line. If you have poor print quality, please modify the printer density or adjust the print head pressure adjustment knob, or adjust z-axis mechanism first.

**Caution:**  
***Incorrectly adjusting print head burn line adjustment knobs can lead to poor print quality and may cause damage to the printer. Proceed with caution.***

Poor print quality when using paper thicker than 0.20mm may be due to the print head burn line not being at the optimized position. To improve the print quality, increase the head pressure or adjust the knobs counter-clockwise to move print head burn line toward the paper out direction then print again. Continue to adjust the burn line position and test print as necessary until the printout image is clear.

## 4.4 Mechanism Fine Adjustment to Avoid Ribbon Wrinkles

This printer has been fully tested before delivery. There should be no ribbon wrinkle presented on the media for general-purpose printing application. Ribbon wrinkle is related to the media thickness, print head pressure balance, ribbon film characteristics, print darkness setting...etc. In case the ribbon wrinkle happens, please follow the instructions below to adjust the printer parts.

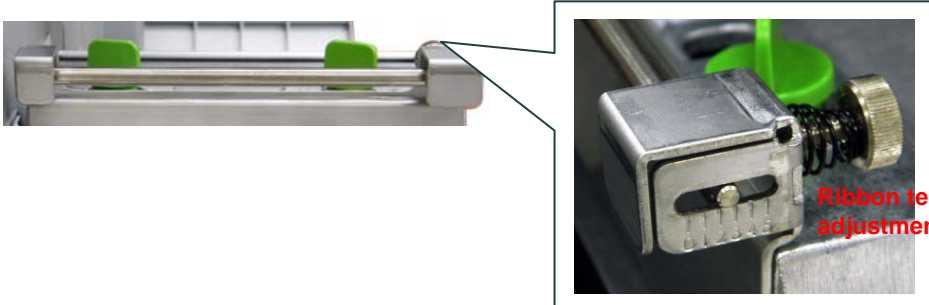
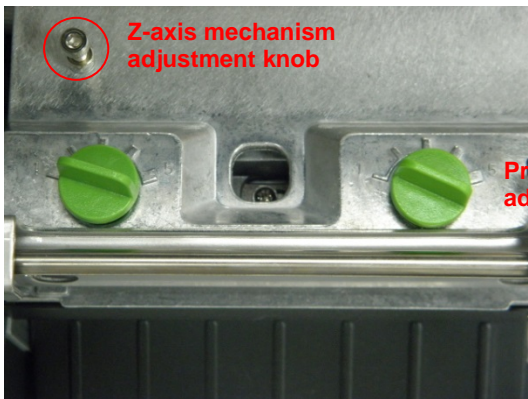
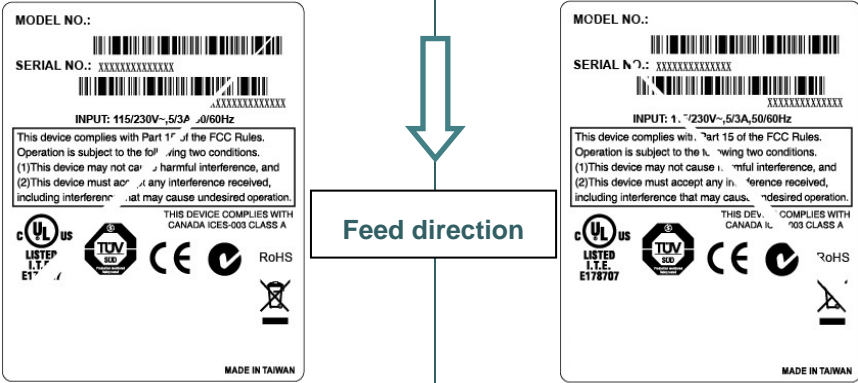
	<p>The ribbon tension adjustment knob has 0 ~ 5 positions for adjustment.</p> 	
<p><b>Adjustable Printer Parts</b></p>	<p>The print head pressure adjustment knob has 5 levels of settings. Clockwise direction adjustment is to increase the print head pressure. Counter Clockwise adjustment can decrease the print head pressure.</p> 	
<p><b>Symptom</b></p>	<p>1. Wrinkle happens from label lower left to upper right direction (“ / ”)</p>	<p>2. Wrinkle happens from label lower right to upper left direction (“ \ ”)</p>
<p><b>Wrinkle Example</b></p>		

<p>If the wrinkle on the label starts from the lower left side to upper right side, please do following adjustment.</p> <ol style="list-style-type: none"> <li>1. Clockwise direction adjust the ribbon tension adjustment knob to “2” or “1” position. Then check if wrinkle is gone.</li> <li>2. Decrease the right side print head pressure adjustment knob setting 1 level per each adjustment then print the label again to check if wrinkle is gone.</li> <li>3. If the right side print head adjustment knob setting has been set to index 1 (the lowest pressure index), please increase the left side print head pressure.</li> <li>4. If the left side print head adjustment knob setting has been set to 5 (the highest pressure index) the wrinkle can't be avoid, please rotate the both knobs back to setting 1 then rotate the Z-axis mechanism adjustment knob clockwise for a few degrees and print again for fine tune the print head pressure distribution.</li> </ol> <p><b>Note for step 4:</b></p> <ul style="list-style-type: none"> <li>*Factory default setting, the Z-axis knob is rotated counter clockwise to the end of thread.</li> <li>*Turn the Z-axis mechanism adjustment knob clockwise until you feel the knob touch the mechanism for the first adjustment.</li> <li>* If the wrinkle is still there, please turn the Z-axis mechanism adjustment knob clockwise about 1/4 circle each time for adjustment</li> <li>* If the winkled direction is change from “/” to “\” by adjusting the Z-axis mechanism adjustment knob, please turn the Z axis mechanism adjustment knob counter clockwise to avoid the wrinkle.</li> </ul>	<p>If the wrinkle on the label starts from the lower right side to upper left side, please do following adjustment.</p> <ol style="list-style-type: none"> <li>1. Counter clockwise adjust the ribbon tension adjustment knob to “4” or “5” position. Then check if wrinkle is gone.</li> <li>2. Decrease the left side print head pressure adjustment knob setting 1 level per each adjustment then print the label again to check if wrinkle is gone.</li> <li>3. If the left side print head adjustment knob level has been set to index 1 (the lowest index), please increase the right side print head pressure.</li> </ol>
--	--

## 5. LCD Menu Function for MT Series

---

### 5.1 Enter the Main Menu

**\* By Keys:**

Press the "MENU" button and press the "SELECT" button to enter the main menu.

**\* By touch display:**

Tap the "Menu" icon on LCD to enter the main menu.

## 5.2 Main Menu Overview

There are 8 categories for the main menu. You can easily set the settings of printer without connecting the computer. Please refer to following sections for more details.

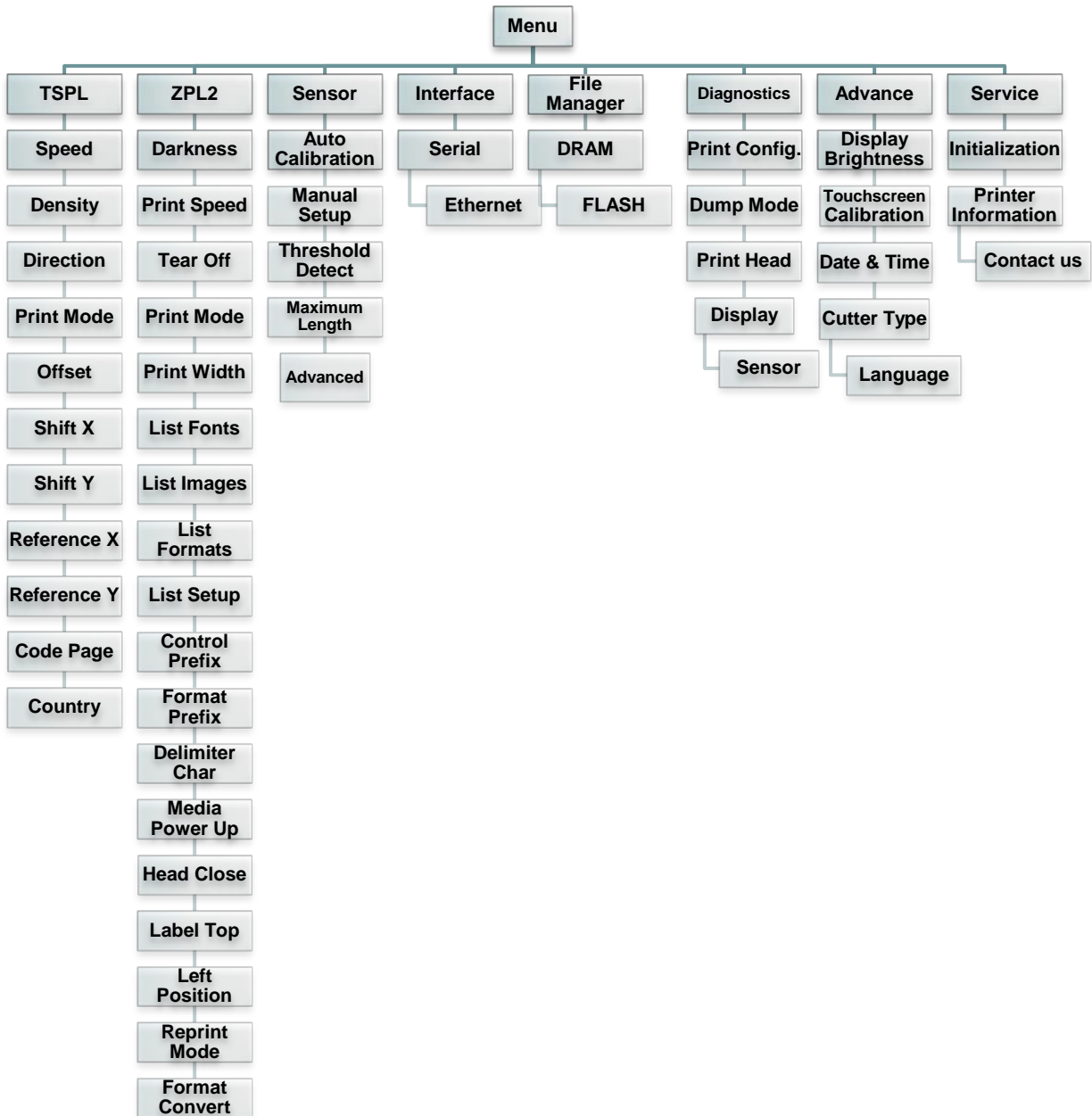

### 5.3 TSPL2

This “TSPL2” category can set up the printer settings for TSPL2.

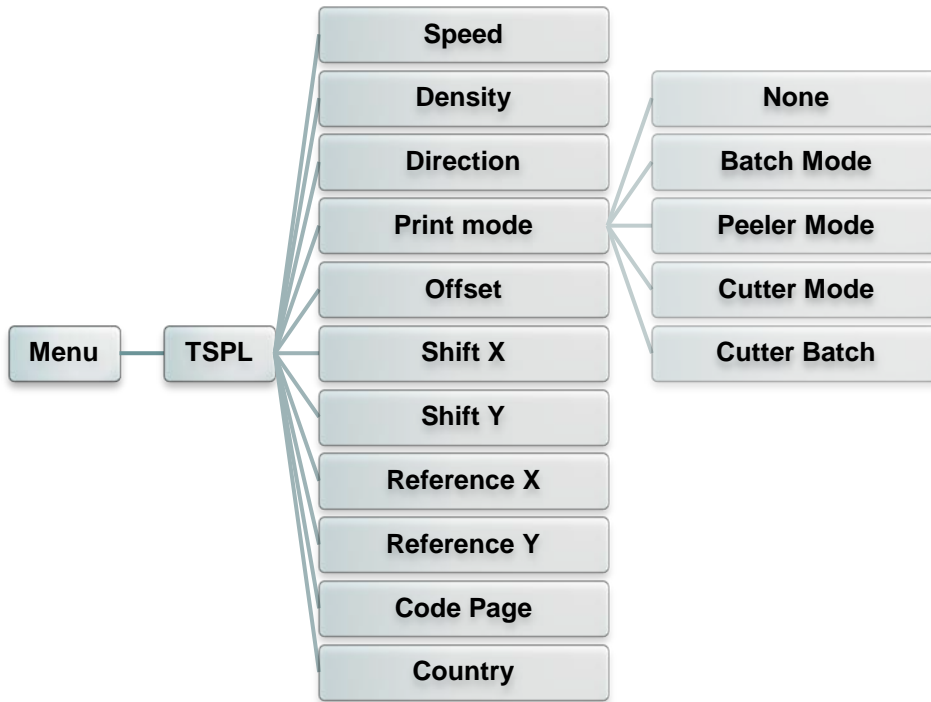

Item	Description	Default				
<b>Speed</b>	Use this item to setup print speed. Available setting range is 4~12 for 203dpi, 2~12 for 300dpi and 1.5 ~6 for 600dpi.	<b>203 dpi: 6 300 dpi: 4 600 dpi: 3</b>				
<b>Density</b>	Use this option to setup printing darkness. The available setting is from 0 to 15, and the step is 1. You may need to adjust your density based on selected media.	<b>8</b>				
<b>Direction</b>	<p>The direction setting value is either 1 or 0. Use this item to setup the printout direction.</p> <div style="border: 1px solid black; padding: 5px; text-align: center;"> <table style="width: 100%; border-collapse: collapse;"> <tr> <td style="width: 50%; border-bottom: 1px solid black;">DIRECTION 0</td> <td style="width: 50%; border-bottom: 1px solid black;">DIRECTION 1</td> </tr> <tr> <td style="border: 1px solid black; text-align: center; padding: 10px;">Direction</td> <td style="border: 1px solid black; text-align: center; padding: 10px;">Direction</td> </tr> </table> <p style="text-align: center; margin-top: 5px;">↓ FEED</p> </div>	DIRECTION 0	DIRECTION 1	Direction	Direction	<b>0</b>
DIRECTION 0	DIRECTION 1					
Direction	Direction					
<b>Print mode</b>	<p>This item is used to set the print mode. There are 5 modes as below,</p> <table border="1" style="width: 100%; border-collapse: collapse;"> <thead> <tr> <th style="width: 30%;">Printer Mode</th> <th>Description</th> </tr> </thead> <tbody> <tr> <td style="text-align: center;">None</td> <td>Next label top of form is aligned to the print head burn line location. (Tear Off Mode)</td> </tr> </tbody> </table>	Printer Mode	Description	None	Next label top of form is aligned to the print head burn line location. (Tear Off Mode)	<b>Batch Mode</b>
Printer Mode	Description					
None	Next label top of form is aligned to the print head burn line location. (Tear Off Mode)					

	Batch Mode	Once image is printed completely, label gap/black mark will be fed to the tear plate location for tear away.	
	Peeler Mode	Enable the label peel off mode.	
	Cutter Mode	Enable the label cutter mode.	
	Cutter Batch	Cut the label once at the end of the printing job.	
<b>Offset</b>	This item is used to fine tune media stop location. Available setting value is from "+" to "-" or "0" to "9".		<b>+000</b>
<b>Shift X</b>	This item is used to fine tune print position. Available setting value is from "+" to "-" or "0" to "9".		<b>+000</b>
<b>Shift Y</b>			<b>+000</b>
<b>Reference X</b>	This item is used to set the origin of printer coordinate system horizontally and vertically. Available setting value is from "0" to "9".		<b>000</b>
<b>Reference Y</b>			<b>000</b>
<b>Code page</b>	Use this item to set the code page of international character set.		<b>850</b>
<b>Country</b>	Use this option to set the country code.		<b>001</b>

***Note: If printing from enclosed software/driver, the software/driver will send out the commands, which will overwrite the settings set from the panel.***



## 5.4 ZPL2

This “ZPL2” category can set up the printer settings for ZPL2.

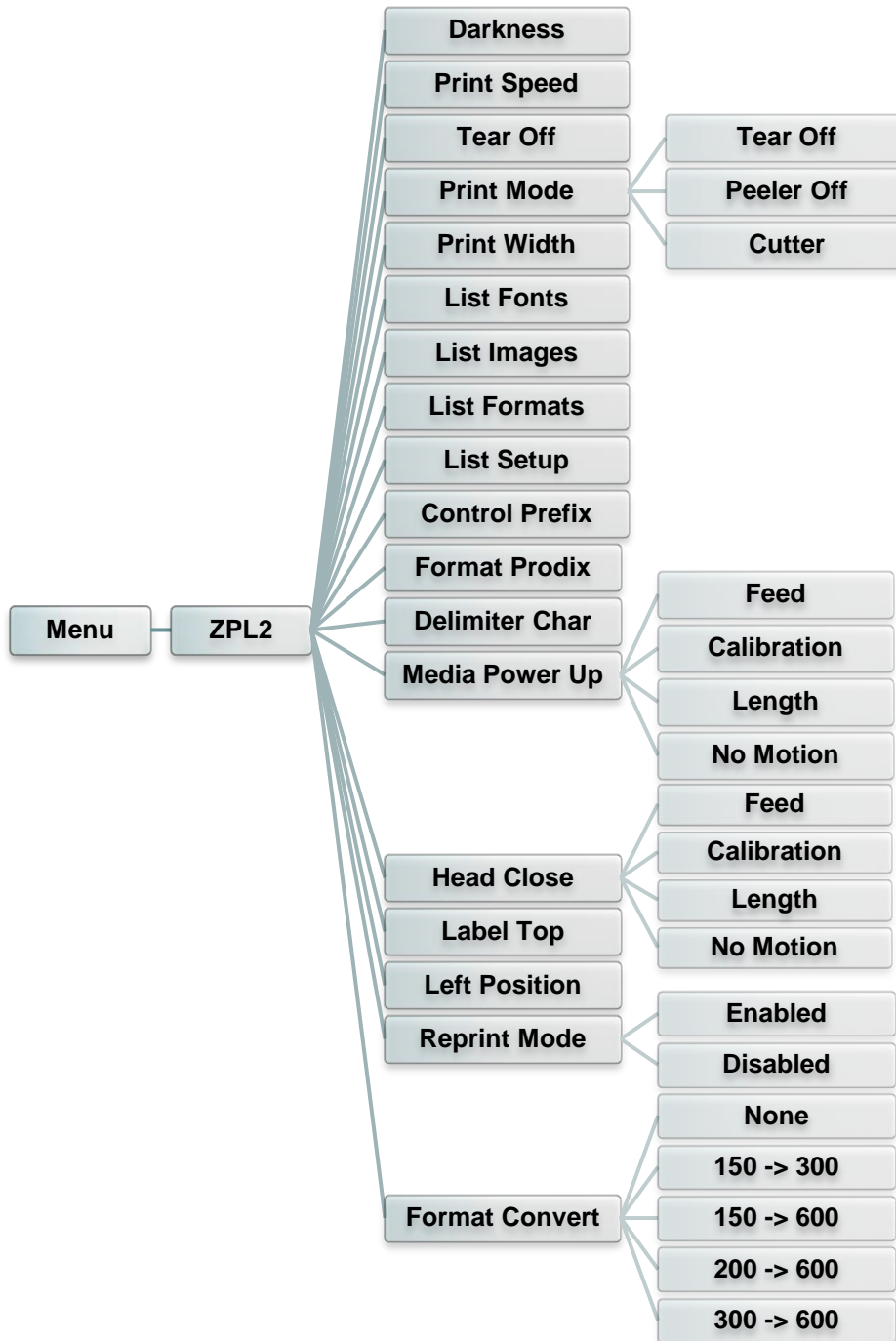

Item	Description	Default
<b>Darkness</b>	Use this item to setup printing darkness. The available setting is from 0 to 30, and the step is 1. You may need to adjust your density based on selected media.	<b>16</b>

<b>Print Speed</b>	Use this item to setup print speed. Available setting range is 4~12 for 203dpi, 2~12 for 300dpi and 1.5 ~6 for 600dpi.	<b>203 dpi: 6 300 dpi: 4 600 dpi: 3</b>										
<b>Tear Off</b>	This item is used to fine tune media stop location. Available setting value is from "+" to "-" or "0" to "9".	<b>+000</b>										
<b>Print mode</b>	<p>This item is used to set the print mode. There are 3 modes as below,</p> <table border="1"> <thead> <tr> <th>Printer Mode</th> <th>Description</th> </tr> </thead> <tbody> <tr> <td>Tear Off</td> <td>Next label top of form is aligned to the print head burn line location.</td> </tr> <tr> <td>Peeler Off</td> <td>Enable the label peel off mode.</td> </tr> <tr> <td>Cutter</td> <td>Enable the label cutter mode</td> </tr> </tbody> </table>	Printer Mode	Description	Tear Off	Next label top of form is aligned to the print head burn line location.	Peeler Off	Enable the label peel off mode.	Cutter	Enable the label cutter mode	<b>Tear Off</b>		
Printer Mode	Description											
Tear Off	Next label top of form is aligned to the print head burn line location.											
Peeler Off	Enable the label peel off mode.											
Cutter	Enable the label cutter mode											
<b>Print Width</b>	This item is used to set print width. The available value is from "0" to "9".	<b>812</b>										
<b>List Fonts</b>	This feature is used to print current printer available fonts list to the label. The fonts stored in the printer's DRAM, Flash or optional memory card.	<b>N/A</b>										
<b>List Images</b>	This feature is used to print current printer available images list to the label. The images stored in the printer's DRAM, Flash or optional memory card.	<b>N/A</b>										
<b>List Formats</b>	This feature is used to print current printer available formats list to the label. The formats stored in the printer's DRAM, Flash or optional memory card.	<b>N/A</b>										
<b>List Setup</b>	This feature is used to print current printer configuration to the label.	<b>N/A</b>										
<b>Control Prefix</b>	This feature is used to set control prefix character.	<b>N/A</b>										
<b>Format Prefix</b>	This feature is used to set format prefix character.	<b>N/A</b>										
<b>Delimiter Char</b>	This feature is used to set delimiter character.	<b>N/A</b>										
<b>Media Power Up</b>	<p>This option is used to set the action of the media when you turn on the printer.</p> <table border="1"> <thead> <tr> <th>Selections</th> <th>Description</th> </tr> </thead> <tbody> <tr> <td>Feed</td> <td>Printer will advance one label</td> </tr> <tr> <td>Calibration</td> <td>Printer will calibration the sensor levels, determine length and feed label</td> </tr> <tr> <td>Length</td> <td>Printer determine length and feed label</td> </tr> <tr> <td>No Motion</td> <td>Printer will not move media</td> </tr> </tbody> </table>	Selections	Description	Feed	Printer will advance one label	Calibration	Printer will calibration the sensor levels, determine length and feed label	Length	Printer determine length and feed label	No Motion	Printer will not move media	<b>No Motion</b>
Selections	Description											
Feed	Printer will advance one label											
Calibration	Printer will calibration the sensor levels, determine length and feed label											
Length	Printer determine length and feed label											
No Motion	Printer will not move media											
<b>Head Close</b>	<p>This option is used to set the action of the media when you close the print head.</p> <table border="1"> <thead> <tr> <th>Selections</th> <th>Description</th> </tr> </thead> <tbody> <tr> <td>Feed</td> <td>Printer will advance one label</td> </tr> <tr> <td>Calibration</td> <td>Printer will calibration the sensor levels, determine length and feed label</td> </tr> <tr> <td>Length</td> <td>Printer determine length and feed label</td> </tr> <tr> <td>No Motion</td> <td>Printer will not move media</td> </tr> </tbody> </table>	Selections	Description	Feed	Printer will advance one label	Calibration	Printer will calibration the sensor levels, determine length and feed label	Length	Printer determine length and feed label	No Motion	Printer will not move media	<b>No Motion</b>
Selections	Description											
Feed	Printer will advance one label											
Calibration	Printer will calibration the sensor levels, determine length and feed label											
Length	Printer determine length and feed label											
No Motion	Printer will not move media											
<b>Label Top</b>	This option is used to adjust print position vertically on the label. The range is -120 to +120 dots.	<b>0</b>										
<b>Left Position</b>	This option is used to adjust print position horizontally on the label. The range is -9999 to +9999 dots.	<b>+0000</b>										

<b>Reprint Mode</b>	When reprint mode is enabled, you can reprint the last label printer by pressing  button on printer's control panel.	<b>Disabled</b>
<b>Format Convert</b>	Selects the bitmap scaling factor. The first number is the original dots per inch (dpi) value; the second, the dpi to which you would like to scale.	<b>None</b>

***Note: If printing from enclosed software/driver, the software/driver will send out the commands, which will overwrite the settings set from the panel.***

## 5.5 Sensor

This option is used to calibrate the selected sensor. We recommend calibrate the sensor before printing when changing the media.

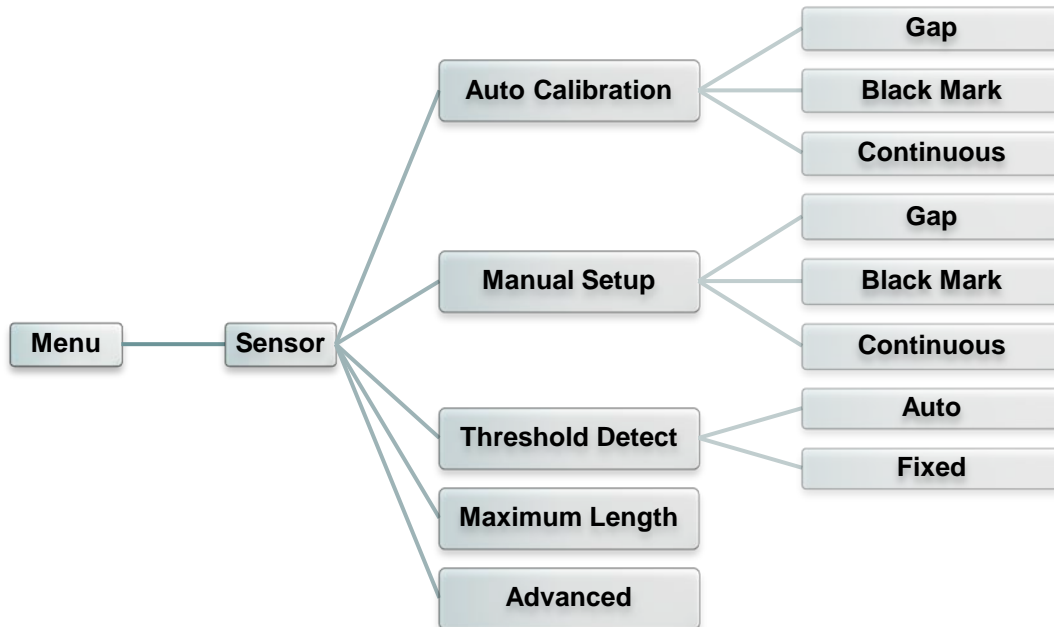

Item	Description	Default
<b>Auto Calibration</b>	This option is used to set the media sensor type and calibrate the selected sensor automatically. Printer will feed 2 to 3 gap labels to calibrate the sensor sensitivity automatically.	<b>N/A</b>
<b>Manual setup</b>	In case "Automatic" cannot apply to the media, please use "Manual" function to set the paper length and gap/bline size then scan the backing/mark to calibrate the sensor sensitivity.	<b>N/A</b>
<b>Threshold Detect</b>	This option is used to set sensor sensitivity in fixed or auto.	<b>Auto</b>
<b>Maximum Length</b>	This option is used to set the maximum length for label calibration.	<b>254 mm</b>
<b>Advanced</b>	This function can set the minimum paper length and maximum gap/bline length for auto-calibrate the sensor sensitivity.	<b>N/A</b>

## 5.6 Interface

This option is used to set the printer interface settings.



### 5.6.1 Serial Comm.

This option is used to set the printer RS-232 settings.

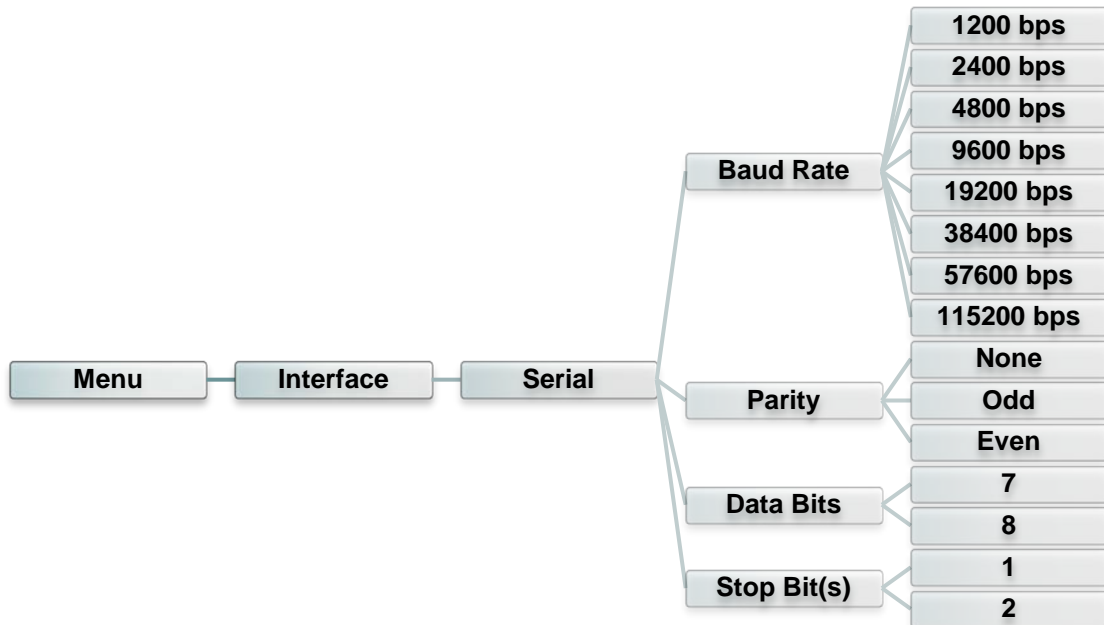

Item	Description	Default
<b>Baud Rate</b>	This item is used to set the RS-232 baud rate.	<b>9600</b>
<b>Parity</b>	This item is used to set the RS-232 parity.	<b>None</b>
<b>Data Bits</b>	This item is used to set the RS-232 Data Bits.	<b>8</b>
<b>Stop Bit(s)</b>	This item is used to set the RS-232 Stop Bits.	<b>1</b>

## 5.6.2 Ethernet

Use this menu to configure internal Ethernet configuration check the printer's Ethernet module status, and reset the Ethernet module.



Item	Description	Default
Status	Use this menu to check the Ethernet IP address and MAC setting status.	N/A
DHCP	This item is used to ON or OFF the DHCP (Dynamic Host Configuration Protocol) network protocol.	N/A
Static IP	Use this menu to set the printer's IP address, subnet mask and gateway.	N/A

# 5.7 File Manager

This feature is used to check the printer available memory and file list.

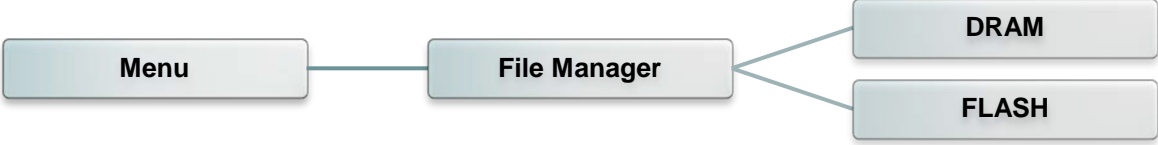

Item	Description
<b>DRAM</b>	Use this menu to show, delete and run (.BAS) the files saved in the printer DRAM memory.
<b>FLASH</b>	Use this menu to show, delete and run (.BAS) the files saved in the printer Flash memory.

## 5.8 Diagnostics

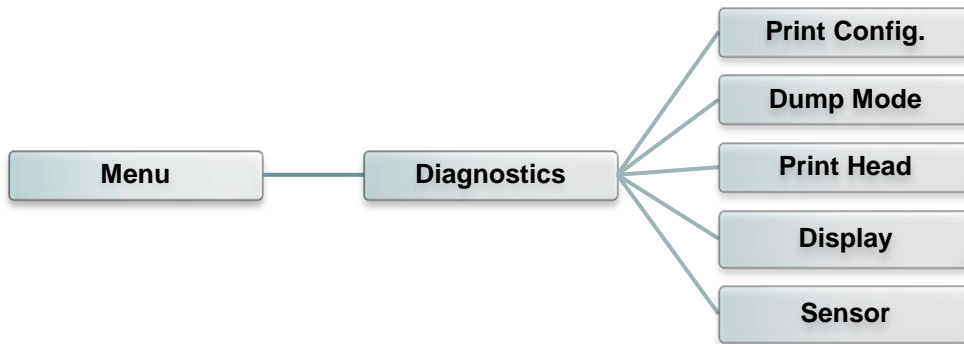

### 5.8.1 Print Config.

This feature is used to print current printer configuration to the label. On the configuration printout, there is a print head test pattern, which is useful for checking if there is any dot damage on the print head heater element.

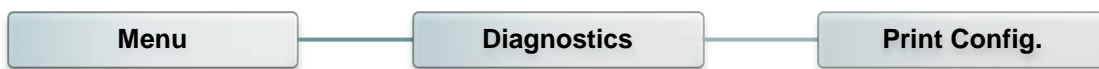

Self-test printout	
-----	
SYSTEM INFORMATION	
-----	
MODEL: XXXXXX	Model name
FIRMWARE: X.XX	F/W version
CHECKSUM: XXXXXXXX	Firmware checksum
S/N: XXXXXXXXXXXX	Printer S/N
TCF: NO	Configuration file
DATE: 1970/01/01	System date
TIME: 00:04:18	System time
NON-RESET: 110 m (TPH)	Printed mileage (meter)
RESET: 110 m (TPH)	
NON-RESET: 0 (CUT)	Cutting counter
RESET: 0 (CUT)	
-----	
PRINTING SETTING	
-----	
SPEED: 5 IPS	Print speed (inch/sec)
DENSITY: 8.0	Print darkness
WIDTH: 4.00 INCH	Label size (inch)
HEIGHT: 4.00 INCH	Gap distance (inch)
GAP: 0.00 INCH	Gap/black mark sensor
INTENSION: 5	intension
CODEPAGE: 850	Code page
COUNTRY: 001	Country code
-----	



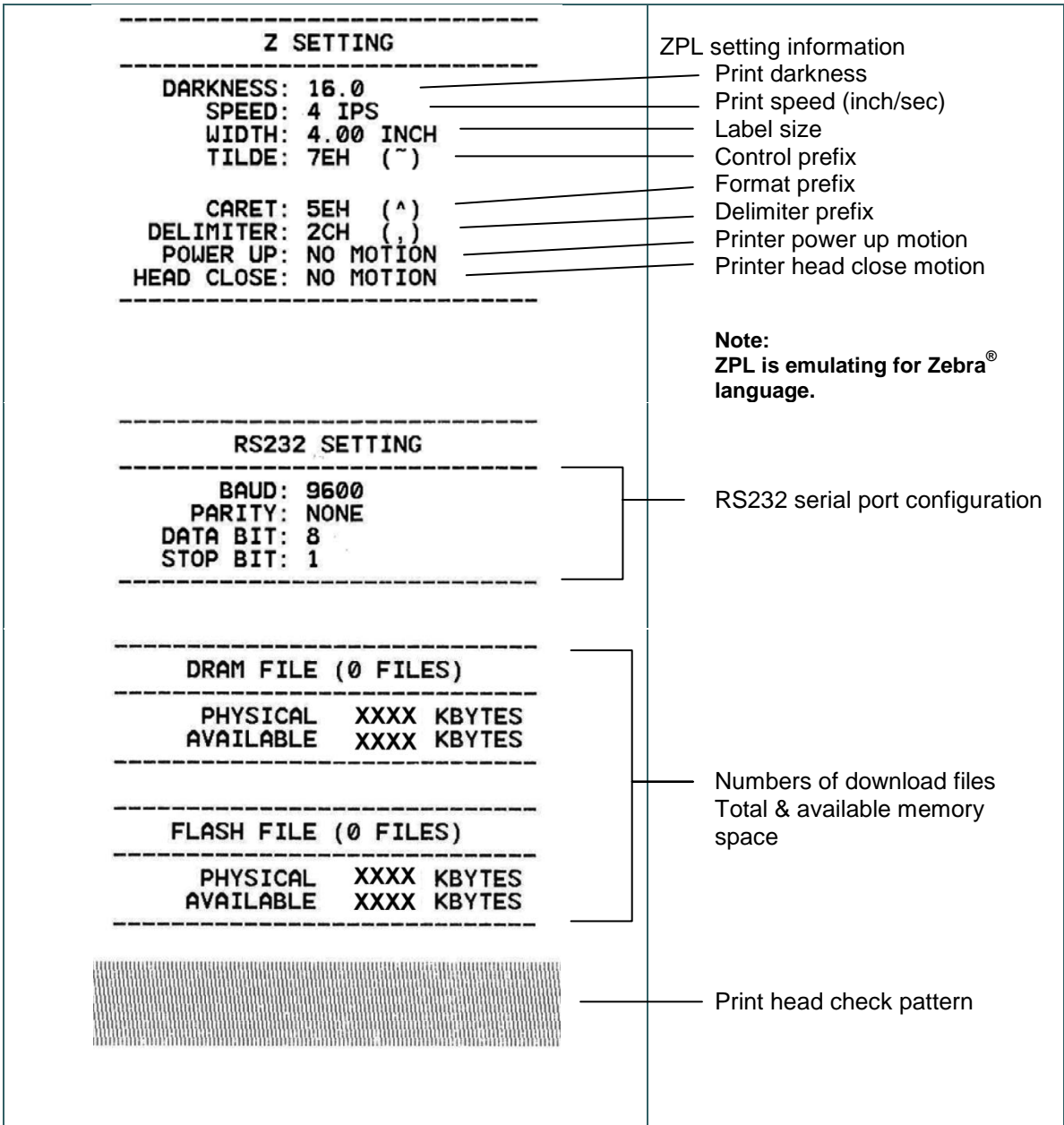

**Note:**  
*Checking dot damage requires 4" wide paper width.*

## 5.8.2 Dump Mode

Captures the data from the communications port and prints out the data received by printer. In the dump mode, all characters will be printed in 2 columns. The left side characters are received from your system and right side data are the corresponding hexadecimal value of the characters. It allows users or engineers to verify and debug the program.



DOWNLOA	0D	0A	44	4F	57	4E	4C	4F	4I
D „TEST2.	44	20	22	54	45	53	54	32	2E
DAT" ,5,CL	44	41	54	22	2C	35	2C	43	4C
S DOWNLO	53	0D	0A	44	4F	57	4E	4C	4F
AD F, „TES	41	44	20	46	2C	22	54	45	53
T4.DAT" ,5	54	34	2E	44	41	54	22	2C	35
,CLS DOW	2C	43	4C	53	0D	0A	44	4F	57
NLOAD „TE	4E	4C	4F	41	44	20	22	54	45
ST2.DAT" ,	53	54	32	2E	44	41	54	22	2C
5,CLS DO	35	2C	43	4C	53	0D	0A	44	4F
WNLOAD F,	57	4E	4C	4F	41	44	20	46	2C
„TEST4.DA	22	54	45	53	54	34	2E	44	41
T" ,5,CLS	54	22	2C	35	2C	43	4C	53	0D
DOWNLOAD	0A	44	4F	57	4E	4C	4F	41	44
"TEST2.D	20	22	54	45	53	54	32	2E	44
AT" ,5,CLS	41	54	22	2C	35	2C	43	4C	53
DOWNLOA	0D	0A	44	4F	57	4E	4C	4F	4I
D F, „TEST	44	20	46	2C	22	54	45	53	54
4.DAT" ,5,	34	2E	44	41	54	22	2C	35	2C
CLS	43	4C	53	0D	0A				

ASCII Data

Hexadecimal data related to left column of ASCII data

**Note:**  
*Dump mode requires 4" wide paper width.*

### 5.8.3 Print Head

This feature can check the temperature, resistance and bad dots for print head.



### 5.8.4 Display

This feature can check the display for printer.



### 5.8.5 Sensor

This feature can check the intension & reading values for printer sensors.

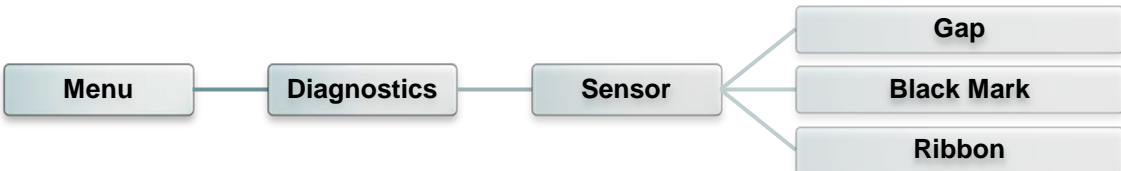

## 5.9 Advanced

This feature is used to set the printer advanced settings.

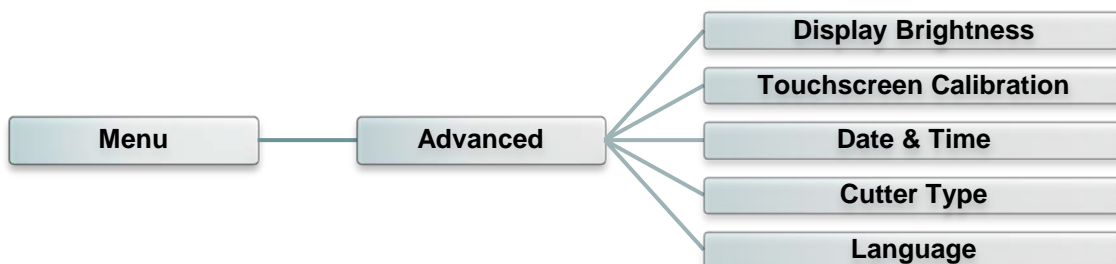

Item	Description
<b>Display Brightness</b>	This item is used to setup the brightness for display.
<b>Touchscreen Calibration</b>	This item is used to calibrate the center of the cross for best result for touchscreen.
<b>Date &amp; Time</b>	This item is used to setup the date and time on display.
<b>Cutter Type</b>	This item is used to set the cutter type.
<b>Language</b>	This item is used to setup the language on display.

## 5.10 Service

This feature is used to restore printer settings to defaults and checking information for printer.



Item	Description
<b>Initialization</b>	This feature is used to restore printer settings to defaults.
<b>Printer Information</b>	This feature is used to check printer serial number, printed mileage(m), labels(pcs.) and cutting counter.
<b>Contact us</b>	This feature is used to check the contact information for tech support service

## 6. LCD Menu Function for MU Series

---

### 6.1 Enter the Main Menu

Press the **MENU** button to enter the main menu or to cancel the setting and return to the previous menu. Press **UP** button to scroll up the menu list. Press **DOWN** button to scroll down the menu list. Press **SELECT** button to set the values into printer.

### 6.2 Main Menu Overview

There are 5 categories for the main menu. You can easy to set the settings of printer without connecting the computer. Please refer to following sections for more details.

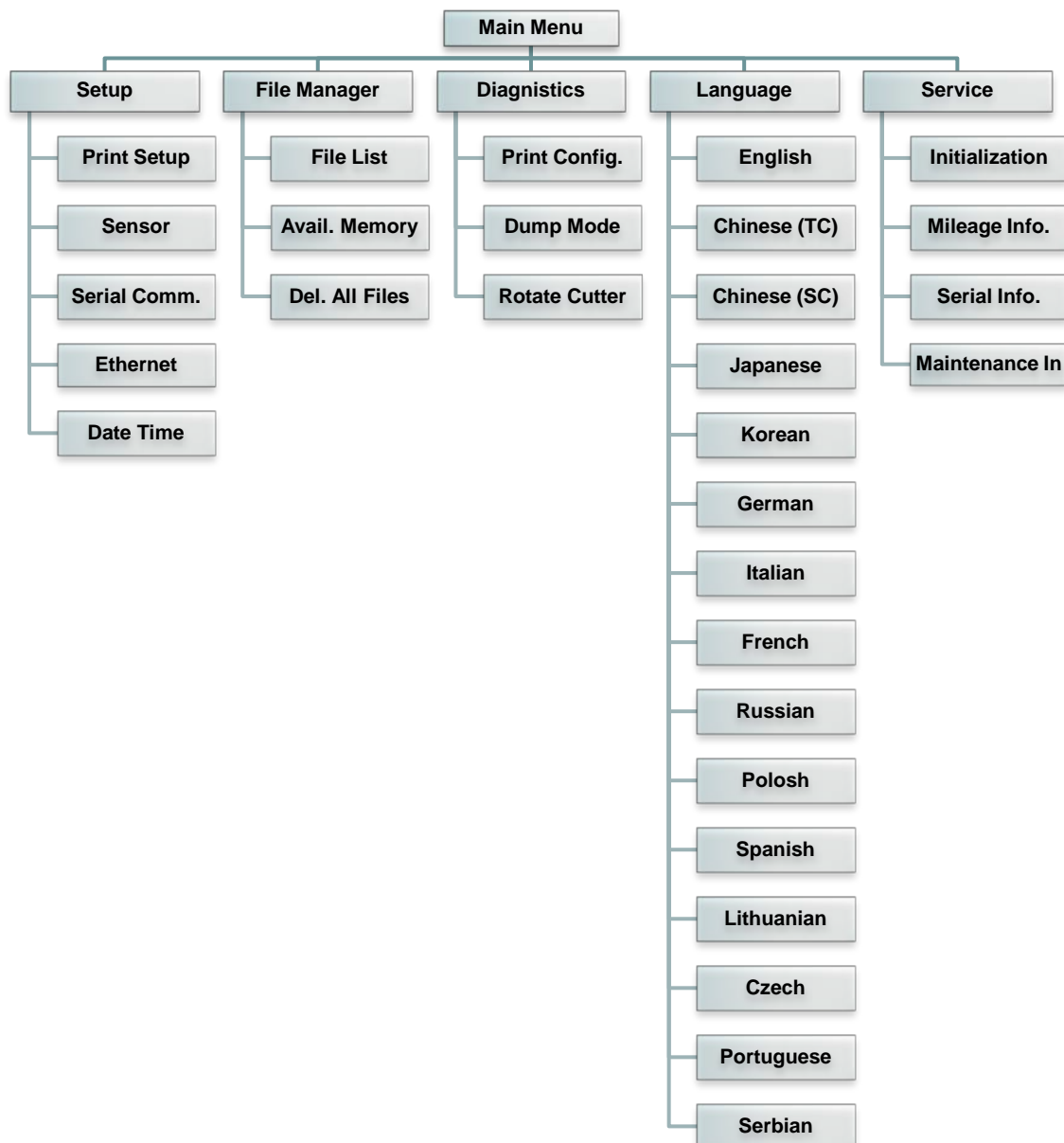

## 6.3 Setup

This “Setup” category can set up the printer settings for TSPL2, ZPL2, sensor, serial interface, and Ethernet interface.

### 6.3.1 Printer Setup (TSPL2/ ZPL2)

#### TSPL2

This “TSPL” category can set up the printer settings for TSPL2.

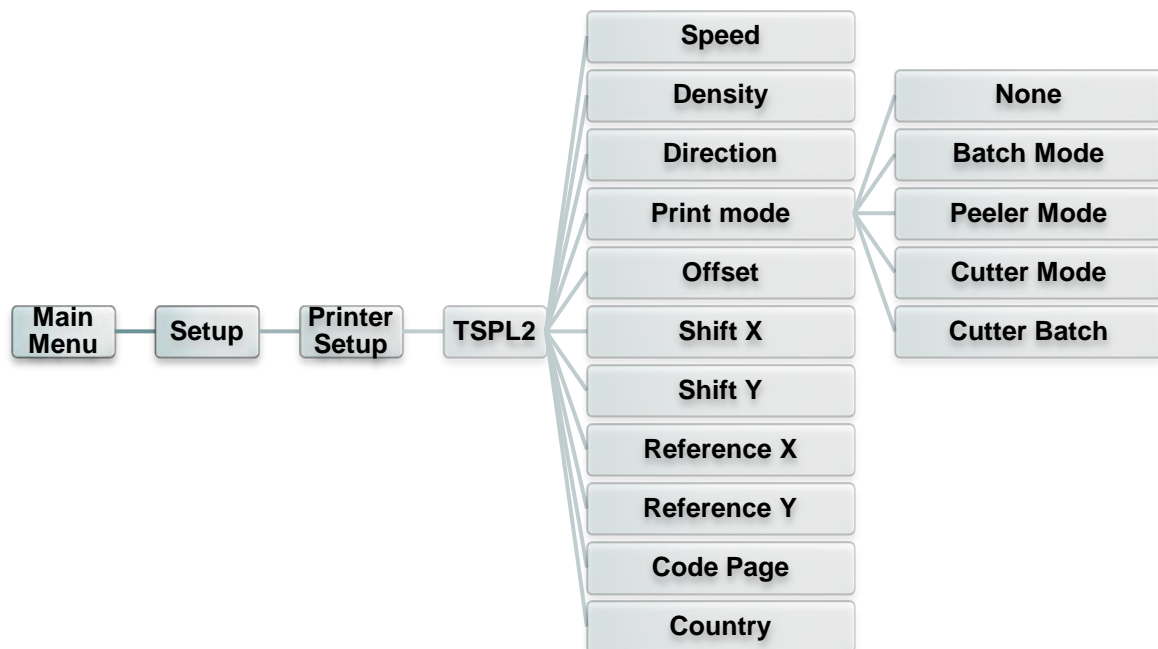

Item	Description	Default
<b>Speed</b>	Use this item to setup print speed. Available setting range is 4~12 for 203dpi, 2~12 for 300dpi and 1.5 ~6 for 600dpi.	<b>203 dpi: 6</b> <b>300 dpi: 4</b> <b>600 dpi: 3</b>
<b>Density</b>	Use this option to setup printing darkness. The available setting is from 0 to 15, and the step is 1. You may need to adjust your density based on selected media.	<b>8</b>

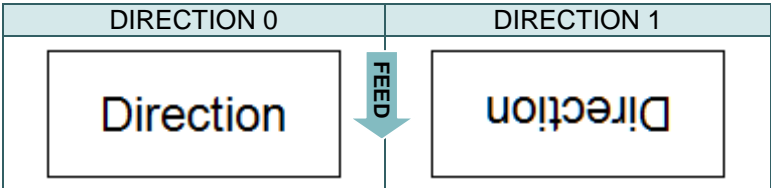
<b>Direction</b>	<p>The direction setting value is either 1 or 0. Use this item to setup the printout direction.</p> 	<b>0</b>												
<b>Print mode</b>	<p>This item is used to set the print mode. There are 5 modes as below,</p> <table border="1" data-bbox="440 539 1257 837"> <thead> <tr> <th>Printer Mode</th> <th>Description</th> </tr> </thead> <tbody> <tr> <td>None</td> <td>Next label top of form is aligned to the print head burn line location. (Tear Off Mode)</td> </tr> <tr> <td>Batch Mode</td> <td>Once image is printed completely, label gap/black mark will be fed to the tear plate location for tear away.</td> </tr> <tr> <td>Peeler Mode</td> <td>Enable the label peel off mode.</td> </tr> <tr> <td>Cutter Mode</td> <td>Enable the label cutter mode.</td> </tr> <tr> <td>Cutter Batch</td> <td>Cut the label once at the end of the printing job.</td> </tr> </tbody> </table>	Printer Mode	Description	None	Next label top of form is aligned to the print head burn line location. (Tear Off Mode)	Batch Mode	Once image is printed completely, label gap/black mark will be fed to the tear plate location for tear away.	Peeler Mode	Enable the label peel off mode.	Cutter Mode	Enable the label cutter mode.	Cutter Batch	Cut the label once at the end of the printing job.	<b>Batch Mode</b>
Printer Mode	Description													
None	Next label top of form is aligned to the print head burn line location. (Tear Off Mode)													
Batch Mode	Once image is printed completely, label gap/black mark will be fed to the tear plate location for tear away.													
Peeler Mode	Enable the label peel off mode.													
Cutter Mode	Enable the label cutter mode.													
Cutter Batch	Cut the label once at the end of the printing job.													
<b>Offset</b>	This item is used to fine tune media stop location. Available setting value is from “+” to “-” or “0” to “9”.	<b>+000</b>												
<b>Shift X</b>	This item is used to fine tune print position. Available setting value is from “+” to “-” or “0” to “9”.	<b>+000</b>												
<b>Shift Y</b>		<b>+000</b>												
<b>Reference X</b>	This item is used to set the origin of printer coordinate system horizontally and vertically. Available setting value is from “0” to “9”.	<b>000</b>												
<b>Reference Y</b>		<b>000</b>												
<b>Code page</b>	Use this item to set the code page of international character set.	<b>850</b>												
<b>Country</b>	Use this option to set the country code.	<b>001</b>												

**Note: If printing from enclosed software/driver, the software/driver will send out the commands, which will overwrite the settings set from the panel.**



## ZPL2

This “ZPL2” category can set up the printer settings for ZPL2.

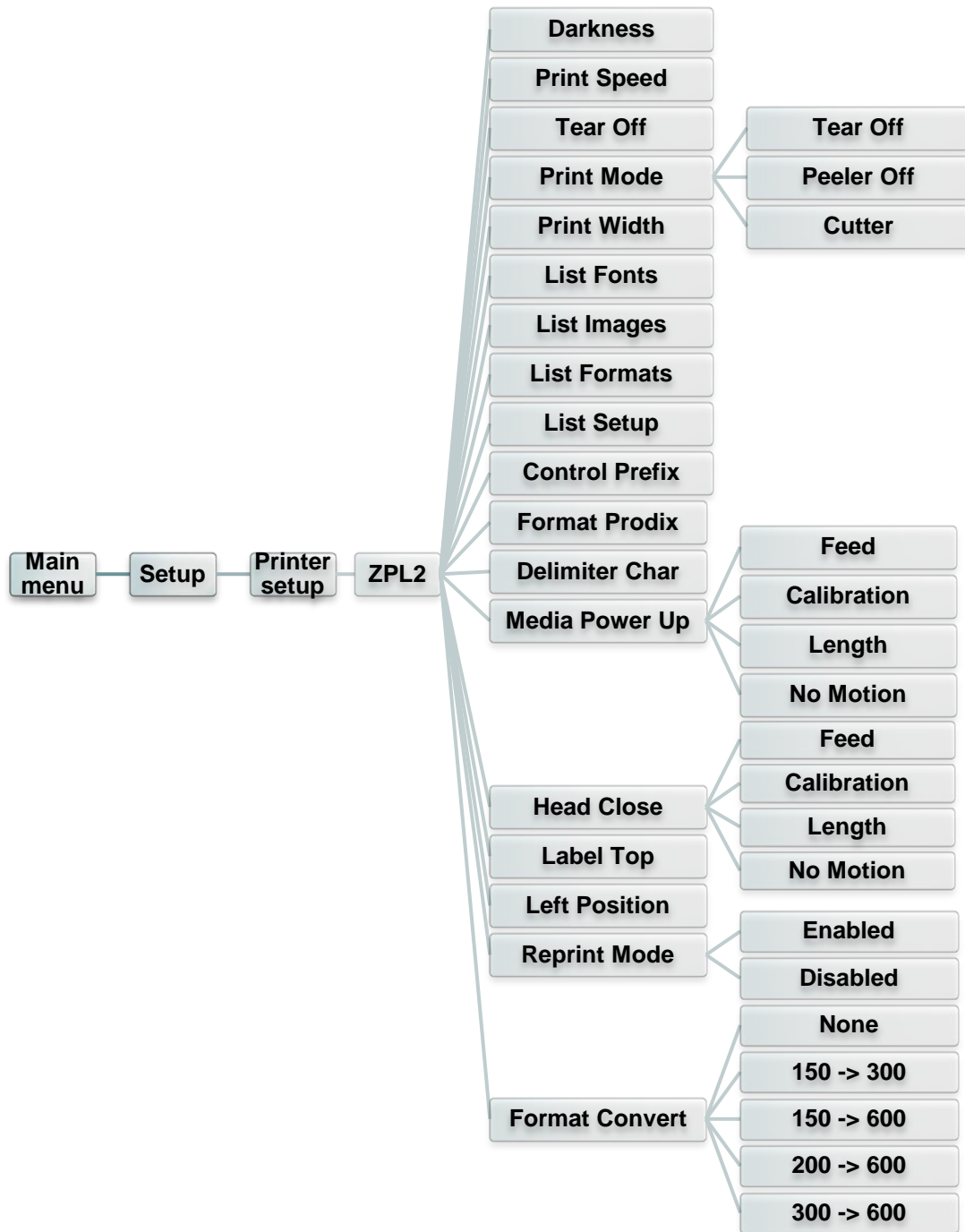

Item	Description	Default
<b>Darkness</b>	Use this item to setup printing darkness. The available setting is from 0 to 30, and the step is 1. You may need to adjust your density based on selected media.	<b>16</b>
<b>Print Speed</b>	Use this item to setup print speed. Available setting range is 4~12 for 203dpi, 2~12 for 300dpi and 1.5 ~6 for 600dpi.	<b>203 dpi: 6 300 dpi: 4 600 dpi: 3</b>

<b>Tear Off</b>	This item is used to fine tune media stop location. Available setting value is from “+” to “-” or “0” to “9”.	<b>+000</b>										
<b>Print mode</b>	<p>This item is used to set the print mode. There are 3 modes as below,</p> <table border="1"> <thead> <tr> <th>Printer Mode</th> <th>Description</th> </tr> </thead> <tbody> <tr> <td>Tear Off</td> <td>Next label top of form is aligned to the print head burn line location.</td> </tr> <tr> <td>Peeler Off</td> <td>Enable the label peel off mode.</td> </tr> <tr> <td>Cutter</td> <td>Enable the label cutter mode</td> </tr> </tbody> </table>	Printer Mode	Description	Tear Off	Next label top of form is aligned to the print head burn line location.	Peeler Off	Enable the label peel off mode.	Cutter	Enable the label cutter mode	<b>Tear Off</b>		
Printer Mode	Description											
Tear Off	Next label top of form is aligned to the print head burn line location.											
Peeler Off	Enable the label peel off mode.											
Cutter	Enable the label cutter mode											
<b>Print Width</b>	This item is used to set print width. The available value is from “0” to “9”.	<b>812</b>										
<b>List Fonts</b>	This feature is used to print current printer available fonts list to the label. The fonts stored in the printer’s DRAM, Flash or optional memory card.	<b>N/A</b>										
<b>List Images</b>	This feature is used to print current printer available images list to the label. The images stored in the printer’s DRAM, Flash or optional memory card.	<b>N/A</b>										
<b>List Formats</b>	This feature is used to print current printer available formats list to the label. The formats stored in the printer’s DRAM, Flash or optional memory card.	<b>N/A</b>										
<b>List Setup</b>	This feature is used to print current printer configuration to the label.	<b>N/A</b>										
<b>Control Prefix</b>	This feature is used to set control prefix character.	<b>N/A</b>										
<b>Format Prefix</b>	This feature is used to set format prefix character.	<b>N/A</b>										
<b>Delimiter Char</b>	This feature is used to set delimiter character.	<b>N/A</b>										
<b>Media Power Up</b>	<p>This option is used to set the action of the media when you turn on the printer.</p> <table border="1"> <thead> <tr> <th>Selections</th> <th>Description</th> </tr> </thead> <tbody> <tr> <td>Feed</td> <td>Printer will advance one label</td> </tr> <tr> <td>Calibration</td> <td>Printer will calibration the sensor levels, determine length and feed label</td> </tr> <tr> <td>Length</td> <td>Printer determine length and feed label</td> </tr> <tr> <td>No Motion</td> <td>Printer will not move media</td> </tr> </tbody> </table>	Selections	Description	Feed	Printer will advance one label	Calibration	Printer will calibration the sensor levels, determine length and feed label	Length	Printer determine length and feed label	No Motion	Printer will not move media	<b>No Motion</b>
Selections	Description											
Feed	Printer will advance one label											
Calibration	Printer will calibration the sensor levels, determine length and feed label											
Length	Printer determine length and feed label											
No Motion	Printer will not move media											
<b>Head Close</b>	<p>This option is used to set the action of the media when you close the print head.</p> <table border="1"> <thead> <tr> <th>Selections</th> <th>Description</th> </tr> </thead> <tbody> <tr> <td>Feed</td> <td>Printer will advance one label</td> </tr> <tr> <td>Calibration</td> <td>Printer will calibration the sensor levels, determine length and feed label</td> </tr> <tr> <td>Length</td> <td>Printer determine length and feed label</td> </tr> <tr> <td>No Motion</td> <td>Printer will not move media</td> </tr> </tbody> </table>	Selections	Description	Feed	Printer will advance one label	Calibration	Printer will calibration the sensor levels, determine length and feed label	Length	Printer determine length and feed label	No Motion	Printer will not move media	<b>No Motion</b>
Selections	Description											
Feed	Printer will advance one label											
Calibration	Printer will calibration the sensor levels, determine length and feed label											
Length	Printer determine length and feed label											
No Motion	Printer will not move media											
<b>Label Top</b>	This option is used to adjust print position vertically on the label. The range is -120 to +120 dots.	<b>0</b>										
<b>Left Position</b>	This option is used to adjust print position horizontally on the label. The range is -9999 to +9999 dots.	<b>+0000</b>										
<b>Reprint Mode</b>	When reprint mode is enabled, you can reprint the last label printer by pressing  button on printer’s control panel.	<b>Disabled</b>										
<b>Format Convert</b>	Selects the bitmap scaling factor. The first number is the	<b>None</b>										

	original dots per inch (dpi) value; the second, the dpi to which you would like to scale.	
--	---	--

***Note: If printing from enclosed software/driver, the software/driver will send out the commands, which will overwrite the settings set from the panel.***

### 6.3.2 Sensor

This option is used to calibrate the selected sensor. We recommend calibrate the sensor before printing when changing the media.

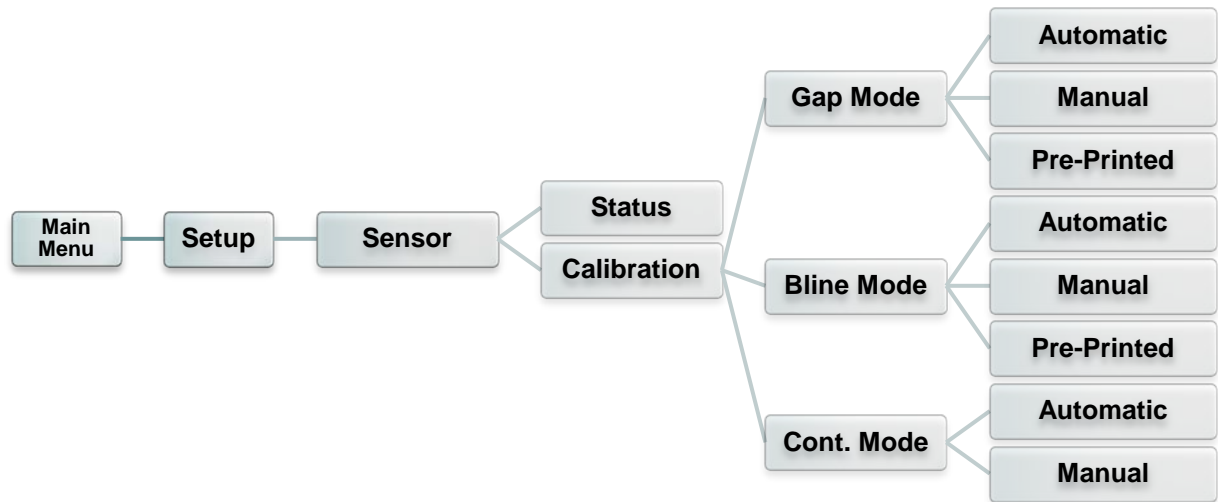

Item	Description	Default
<b>Status</b>	This function is available to check the printer's sensor status.	<b>N/A</b>
<b>Gap Mode</b>	This item is used to set the gap media sensor type and calibrate the sensor.	<b>N/A</b>
<b>Bline Mode</b>	This item is used to set the black mark media sensor type and calibrate the sensor.	<b>N/A</b>
<b>Cont. Mode</b>	This item is used to set the continuous media sensor type and calibrate the sensor.	<b>N/A</b>
<b>Automatic</b>	Printer will feed 2 to 3 gap labels to calibrate the sensor sensitivity automatically.	<b>N/A</b>
<b>Manual</b>	In case "Automatic" cannot apply to the media, please use "Manual" function to set the paper length and gap/bline size then scan the backing/mark to calibrate the sensor sensitivity.	<b>N/A</b>
<b>Pre-Printed</b>	This function can set the min. paper length and max gap/bline length before auto-calibrate the sensor sensitivity.	<b>N/A</b>

### 6.3.3 Serial Comm.

This option is used to set the printer RS-232 settings.

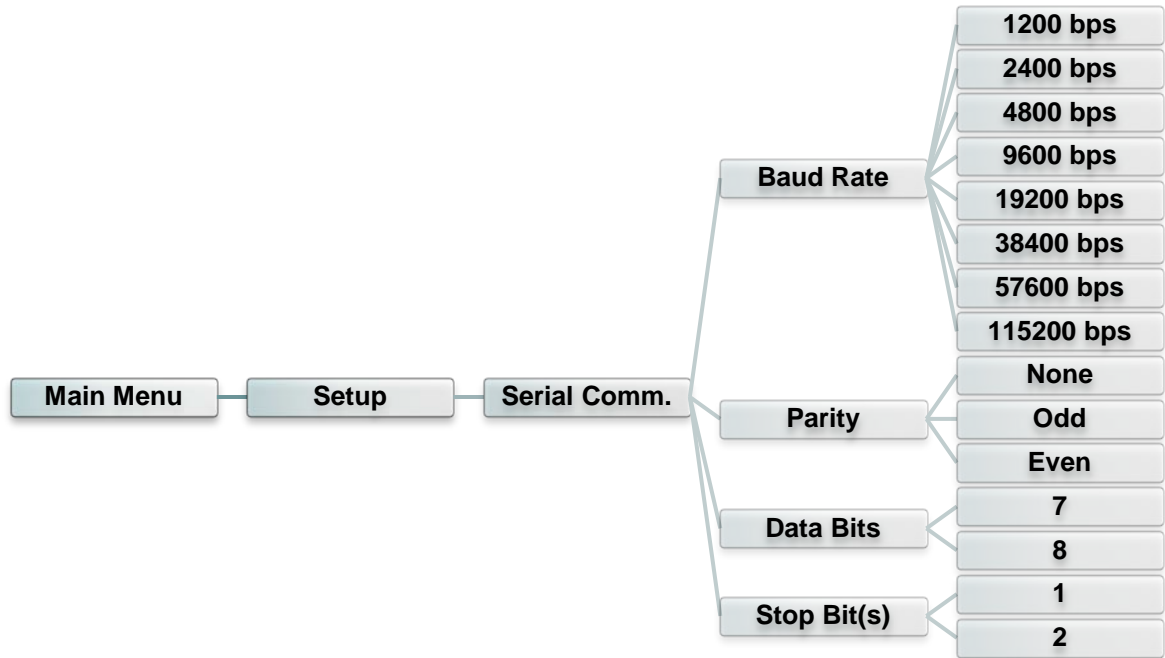

Item	Description	Default
<b>Baud Rate</b>	This item is used to set the RS-232 baud rate.	<b>9600</b>
<b>Parity</b>	This item is used to set the RS-232 parity.	<b>None</b>
<b>Data Bits</b>	This item is used to set the RS-232 Data Bits.	<b>8</b>
<b>Stop Bit(s)</b>	This item is used to set the RS-232 Stop Bits.	<b>1</b>

### 6.3.4 Date Time

This option is used to set the date & time for RTC.

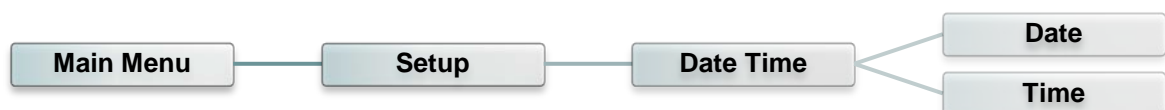

## 6.4 File Manager

This feature is used to check the printer available memory and file list.

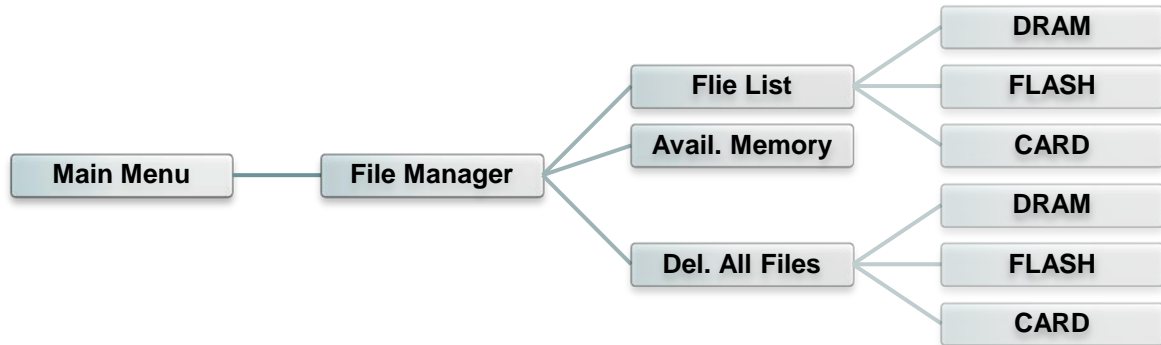

Item	Description
<b>File List</b>	Use this menu to show, delete and run (.BAS) the files saved in the printer DRAM/Flash/Card memory.
<b>Avail. Memory</b>	Use this menu to show available memory space.
<b>Del. All Files</b>	Use this menu to delete all files.

## 6.5 Diagnostics



### 6.5.1 Print Config.

This feature is used to print current printer configuration to the label. On the configuration printout, there is a print head test pattern, which is useful for checking if there is any dot damage on the print head heater element.

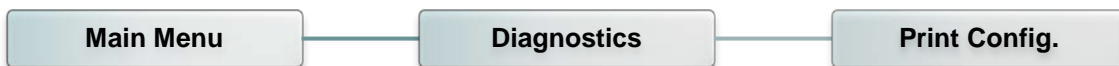

Self-test printout	
-----	
SYSTEM INFORMATION	
-----	
MODEL: XXXXXX	Model name
FIRMWARE: X.XX	F/W version
CHECKSUM: XXXXXXXX	Firmware checksum
S/N: XXXXXXXXXXXX	Printer S/N
TCF: NO	Configuration file
DATE: 1970/01/01	System date
TIME: 00:04:18	System time
NON-RESET: 110 m (TPH)	Printed mileage (meter)
RESET: 110 m (TPH)	
NON-RESET: 0 (CUT)	Cutting counter
RESET: 0 (CUT)	
-----	
PRINTING SETTING	
-----	
SPEED: 5 IPS	Print speed (inch/sec)
DENSITY: 8.0	Print darkness
WIDTH: 4.00 INCH	Label size (inch)
HEIGHT: 4.00 INCH	Gap distance (inch)
GAP: 0.00 INCH	Gap/black mark sensor
INTENSION: 5	intension
CODEPAGE: 850	Code page
COUNTRY: 001	Country code
-----	

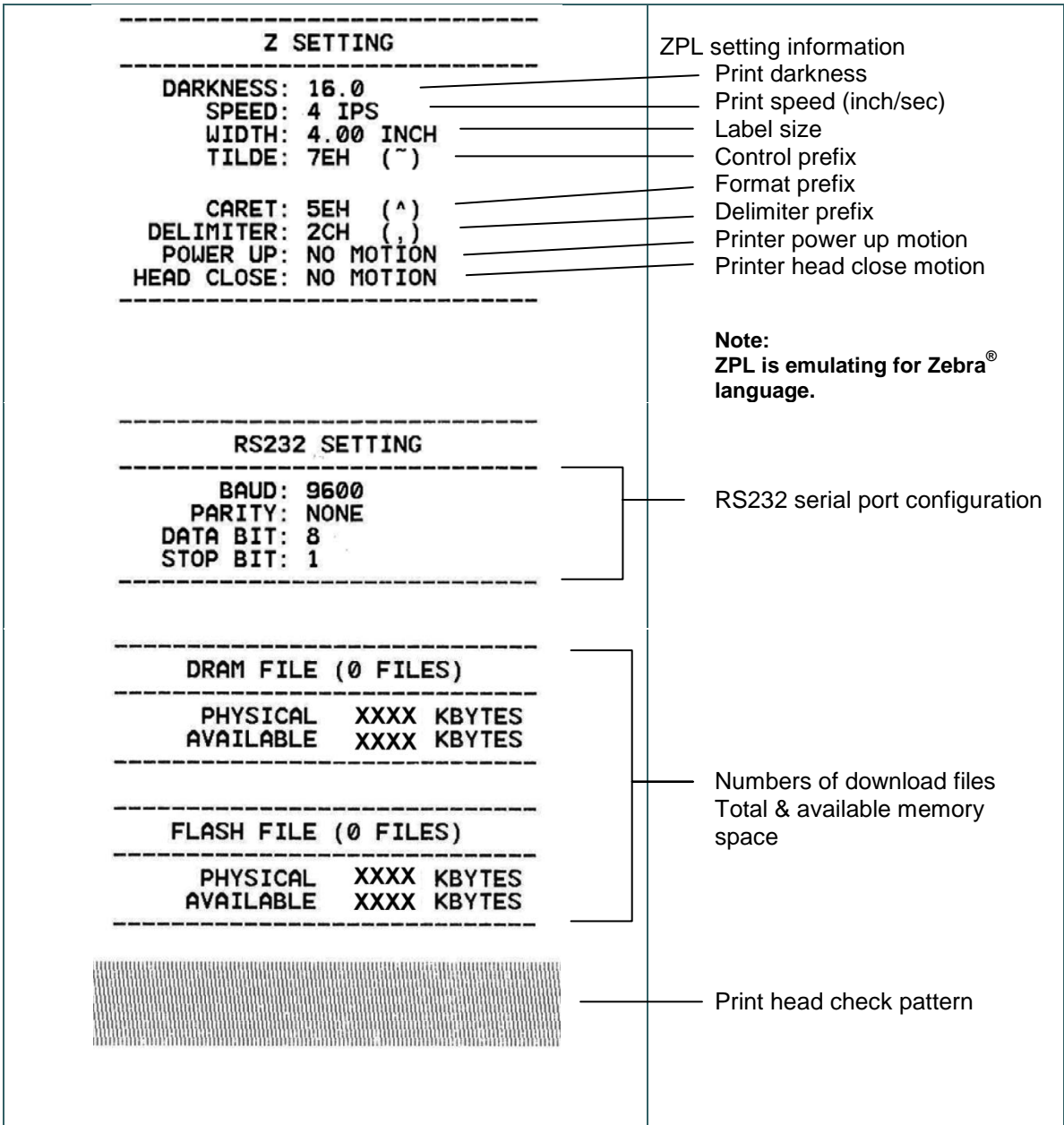

**Note:**  
Checking dot damage requires 4" wide paper width.



## 6.5.2 Dump Mode

Captures the data from the communications port and prints out the data received by printer. In the dump mode, all characters will be printed in 2 columns. The left side characters are received from your system and right side data are the corresponding hexadecimal value of the characters. It allows users or engineers to verify and debug the program.

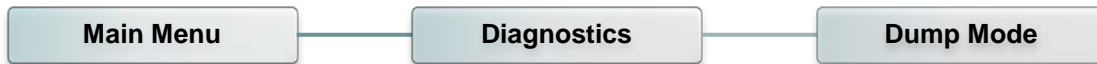

DOWNLOA	0D	0A	44	4F	57	4E	4C	4F	4I
D „TEST2.	44	20	22	54	45	53	54	32	2E
DAT" ,5,CL	44	41	54	22	2C	35	2C	43	4C
S DOWNLO	53	0D	0A	44	4F	57	4E	4C	4F
AD F, „TES	41	44	20	46	2C	22	54	45	53
T4.DAT" ,5	54	34	2E	44	41	54	22	2C	35
,CLS DOW	2C	43	4C	53	0D	0A	44	4F	57
NLOAD „TE	4E	4C	4F	41	44	20	22	54	45
ST2.DAT" ,	53	54	32	2E	44	41	54	22	2C
5,CLS DO	35	2C	43	4C	53	0D	0A	44	4F
WNLOAD F,	57	4E	4C	4F	41	44	20	46	2C
„TEST4.DA	22	54	45	53	54	34	2E	44	41
T" ,5,CLS	54	22	2C	35	2C	43	4C	53	0D
DOWNLOAD	0A	44	4F	57	4E	4C	4F	41	44
"TEST2.D	20	22	54	45	53	54	32	2E	44
AT" ,5,CLS	41	54	22	2C	35	2C	43	4C	53
DOWNLOA	0D	0A	44	4F	57	4E	4C	4F	4I
D F, „TEST	44	20	46	2C	22	54	45	53	54
4.DAT" ,5,	34	2E	44	41	54	22	2C	35	2C
CLS	43	4C	53	0D	0A				

**ASCII Data** (indicated by a red arrow pointing to the left column of the table)

**Hexadecimal data related to left column of ASCII data** (indicated by a red arrow pointing to the right column of the table)

**Note:**  
*Dump mode requires 4" wide paper width.*

### 6.5.3 Rotate Cutter

In case paper is jammed in the cutter, this feature can rotate the cutter blade forward or reverse direction, which is helpful to remove the jammed paper easily from the cutter.



# 6.6 Language

This item is used to setup the language on display.

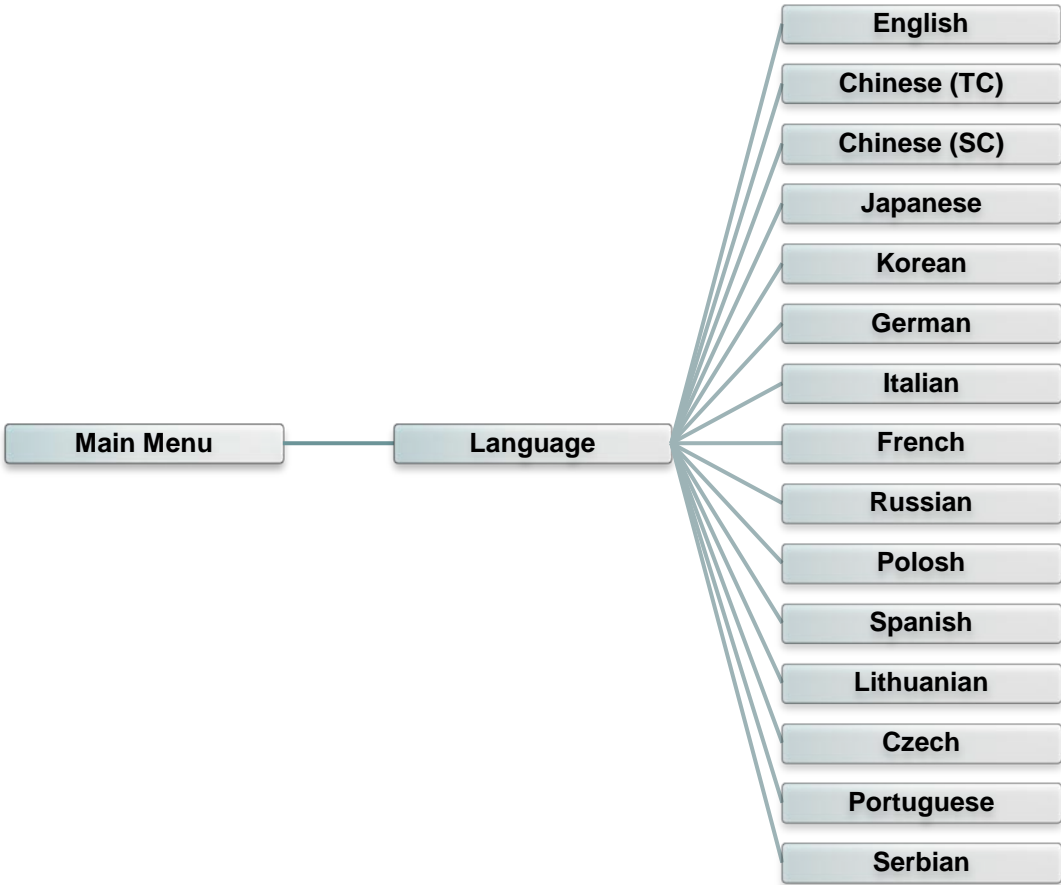

## 6.7 Service

This feature is used to restore printer settings to defaults and checking information for printer.



Item	Description
<b>Initialization</b>	This feature is used to restore printer settings to defaults.
<b>Mileage Info.</b>	This feature is used to check the printed mileage
<b>Serial Info.</b>	This feature is used to check the printer serial number
<b>Maintenance Info</b>	This feature is used to check the maintenance information

## 7. Diagnostic Tool

TSC's Diagnostic Utility is an integrated tool incorporating features that enable you to explore a printer's settings/status; change a printer's settings; download graphics, fonts and firmware; create a printer bitmap font; and send additional commands to a printer. With the aid of this powerful tool, you can review printer status and setting in an instant, which makes it much easier to troubleshoot problems and other issues.

### 7.1 Start the Diagnostic Tool

1. Double click on the Diagnostic tool icon   to start the software.
2. There are four features (Printer Configuration, File Manager, Bitmap Font Manager, Command Tool) included in the Diagnostic utility.

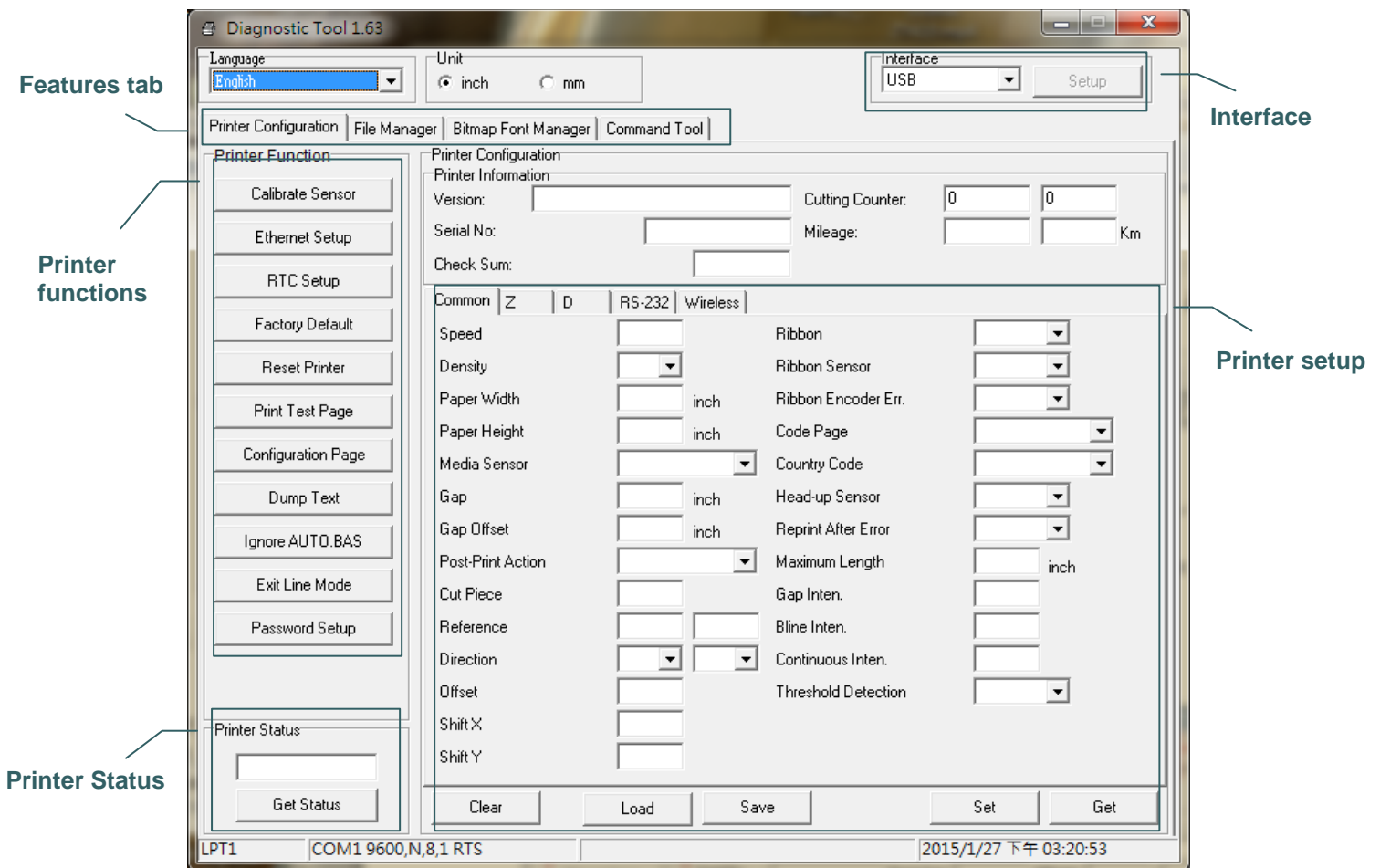

## 7.2 Printer Function

1. Connect the printer and computer with a cable.
2. Select the PC interface connected with bar code printer.

USB cable	Other cable
Interface USB <input type="button" value="Setup"/>	Interface COM <input type="button" value="Setup"/> <b>2</b> USB COM <b>1</b> LPT ETHERNET
The default interface setting is USB interface. If USB interface is connected with printer, no other settings need to be changed in the interface field.	

3. Click the “Printer Function” button to setup.
4. The detail functions in the Printer Function Group are listed as below.

Printer Function	Function	Description
<input type="button" value="Calibrate Sensor"/>	Calibrate Sensor	Calibrate the sensor specified in the Printer Setup group media sensor field
<input type="button" value="Ethernet Setup"/>	Ethernet Setup	Setup the IP address, subnet mask, gateway for the on board Ethernet
<input type="button" value="RTC Setup"/>	RTC Setup	Synchronize printer Real Time Clock with PC
<input type="button" value="Factory Default"/>	Factory Default	Initialize the printer and restore the settings to factory default.
<input type="button" value="Reset Printer"/>	Reset Printer	Reboot printer
<input type="button" value="Print Test Page"/>	Print Test Page	Print a test page
<input type="button" value="Configuration Page"/>	Configuration Page	Print printer configuration
<input type="button" value="Dump Text"/>	Dump Text	To activate the printer dump mode.
<input type="button" value="Ignore AUTO.BAS"/>	Ignore AUTO.BAS	Ignore the downloaded AUTO.BAS program
<input type="button" value="Exit Line Mode"/>	Exit Line Mode	Exit line mode.
<input type="button" value="Password Setup"/>	Password Setup	Set the password to protect the settings

For more information about Diagnostic Tool, please refer to the diagnostic utility quick start guide in the CD disk \ Utilities directory.

## 7.3 Setting Ethernet by Diagnostic Tool

The Diagnostic Utility is enclosed in the CD disk \Utilities directory. Users can use Diagnostic Tool to setup the Ethernet by RS-232, USB and Ethernet interfaces. The following contents will instruct users how to configure the Ethernet by these three interfaces.

### 7.3.1 Using USB interface to setup Ethernet interface

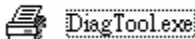
1. Connect the printer and computer with USB cable.
2. Turn on the printer power switch.
3. Start the Diagnostic Utility by double clicking on the  icon.
4. The Diagnostic Utility default interface setting is USB interface. If USB interface is connected with printer, no other settings need to be changed in the interface field.

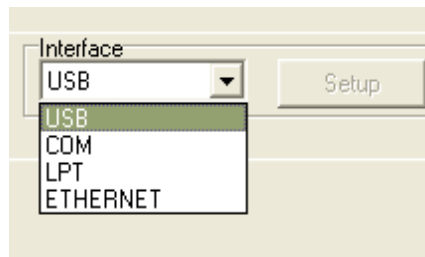

5. Click on the "Ethernet Setup" button from "Printer Function" group in Printer Configuration tab to setup the IP address, subnet mask and gateway for the on board Ethernet.

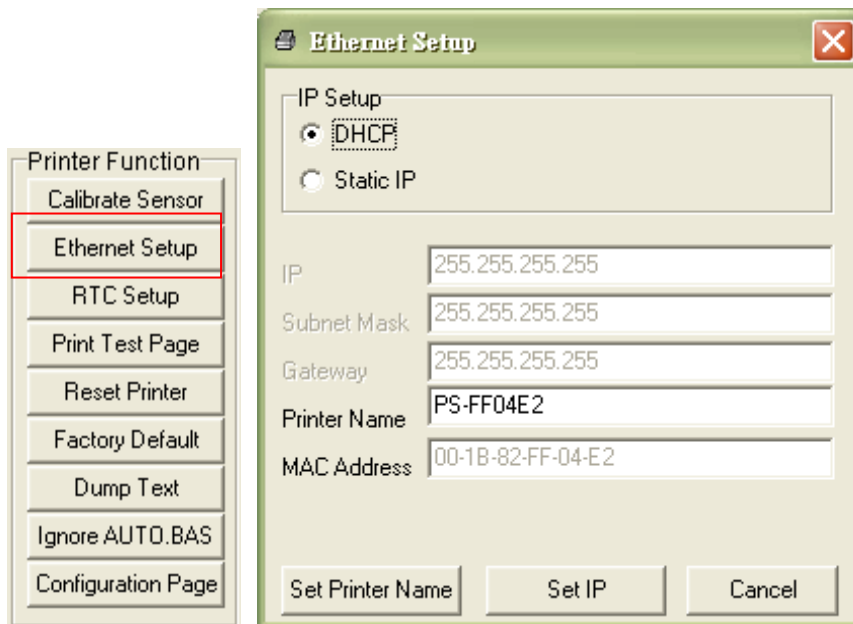

### 7.3.2 Using RS-232 interface to setup Ethernet interface

1. Connect the computer and the printer with a RS-232 cable.
2. Turn on the printer power.
3. Start the Diagnostic Utility by double clicks on the  `DiagTool.exe` icon.
4. Select “COM” as interface then click on the “Setup” button to setup the serial port baud rate, parity check, data bits, stop bit and flow control parameters.

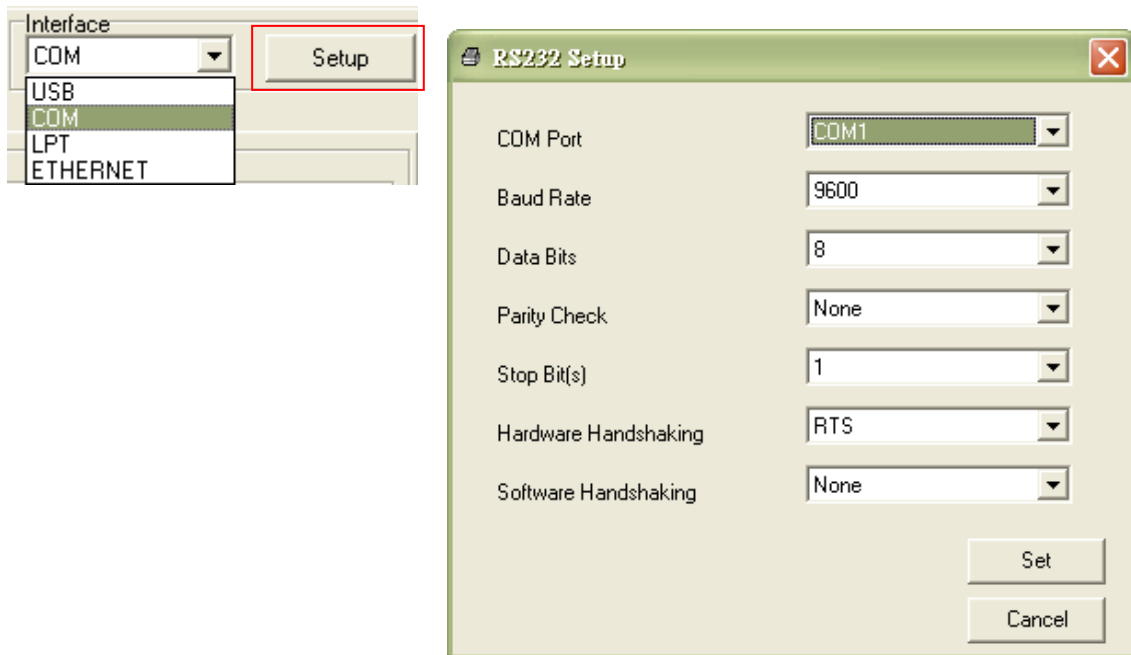

5. Click on the “Ethernet Setup” button from printer function of Printer Configuration tab to setup the IP address, subnet mask and the gateway for the on board Ethernet.

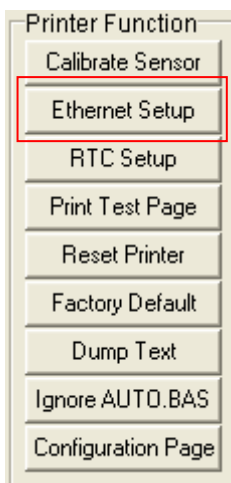



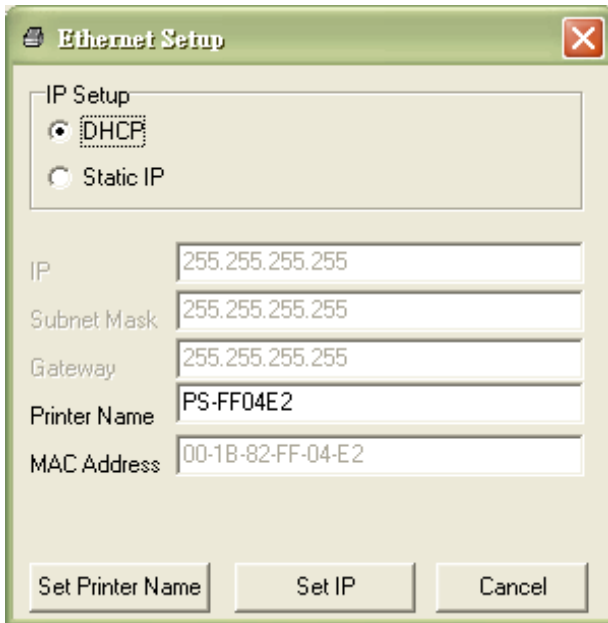

### 6.3.3 Using Ethernet interface to setup Ethernet interface

1. Connect the computer and the printer to the LAN.
2. Turn on the printer power.
3. Start the Diagnostic Utility by double clicks on the  `DiagTool.exe` icon.
4. Select “Ethernet” as the interface then click on the “Setup” button to setup the IP address, subnet mask and gateway for the on board Ethernet.

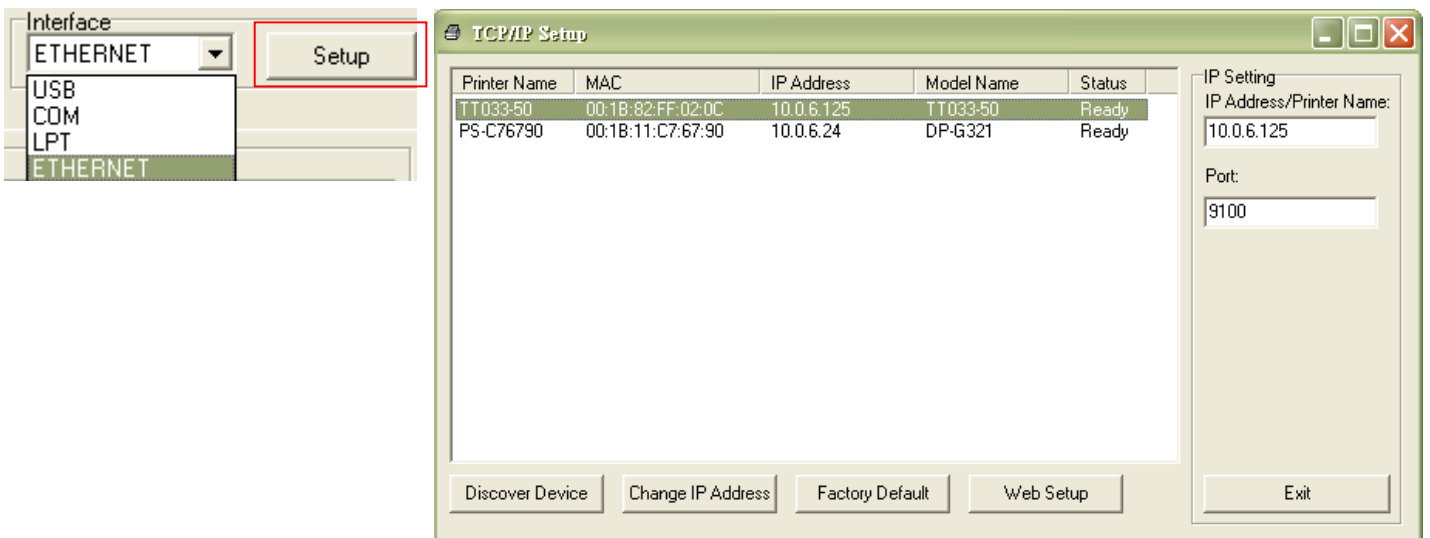

5. Click the “Discover Device” button to explore the printers that exist on the network.

6. Select the printer in the left side of listed printers, the correspondent IP address will be shown in the right side “IP address/Printer Name” field.
7. Click “Change IP Address” to configure the IP address obtained by DHCP or static.

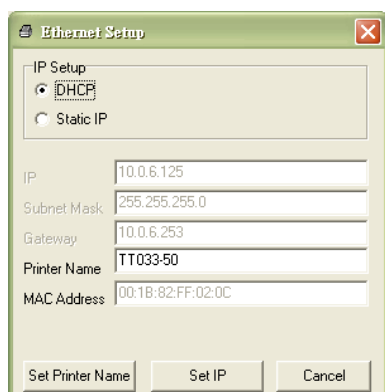

The default IP address is obtained by DHCP. To change the setting to static IP address, click “Static IP” radio button then enter the IP address, subnet mask and gateway. Click “Set IP” to take effect the settings.

Users can also change the “Printer Name” by another model name in this fields then click “Set Printer Name” to take effect this change.

**Note: After clicking the “Set Printer Name” or “Set IP” button, printer will reset to take effect the settings.**

8. Click “Exit” button to exit the Ethernet interface setup and go back to Diagnostic Tool main screen.

Factory Default button

This function will reset the IP, subnet mask, gateway parameters obtained by DHCP and reset the printer name.

Web setup button

Except to use the Diagnostic Utility to setup the printer, you can also explore and configure the printer settings and status or update the firmware with the IE or Firefox web browser. This feature provides a user friendly setup interface and the capability to manage the printer remotely over a network.

## 8. Troubleshooting

The following guide lists the most common problems that may be encountered when operating this bar code printer. If the printer still does not function after all suggested solutions have been invoked, please contact the Customer Service Department of your purchased reseller or distributor for assistance.

Problem	Possible Cause	Recovery Procedure
<b>Power indicator does not illuminate</b>	* The power cord is not properly connected.	* Plug the power cord in printer and outlet. * Switch the printer on.
<b>Carriage Open</b>	* The printer carriages are open.	* Please close the print carriages.
<b>Not Printing</b>	* Check if interface cable is well connected to the interface connector. * Check if wireless or Bluetooth device is well connected between host and printer. * The port specified in the Windows driver is not correct.	* Re-connect cable to interface or change a new cable. * Please reset the wireless device setting. * Select the correct printer port in the driver. * Clean the printhead. * Printhead's harness connector is not well connected with printhead. Turn off the printer and plug the connector again. * Check your program if there is a command PRINT at the end of the file and there must have CRLF at the end of each command line.
<b>No print on the label</b>	* Label or ribbon is loaded not correctly. * Use wrong type paper or ribbon	* Follow the instructions in loading the media and ribbon. * Ribbon and media are not compatible. * Verify the ribbon-inked side. * The print density setting is incorrect.
<b>No Ribbon</b>	* Running out of ribbon. * The ribbon is installed incorrectly.	* Supply a new ribbon roll. * Please refer to the steps in user's manual to reinstall the ribbon.
<b>No Paper</b>	* Running out of label. * The label is installed incorrectly. * Gap/black mark sensor is not calibrated.	* Supply a new label roll. * Please refer to the steps in user's manual to reinstall the label roll. * Calibrate the gap/black mark sensor.
<b>Paper Jam</b>	* Gap/black mark sensor is not set properly. * Make sure label size is set properly. * Labels may be stuck inside the printer mechanism.	* Calibrate the media sensor. * Set media size correctly. * Remove the stuck label inside the printer mechanism.
<b>Take Label</b>	* Peel function is enabled.	* If the peeler module is installed, please remove the label. * If there is no peeler module in front of the printer, please switch off the printer and install it. * Check if the connector is plugging correctly.
<b>Can't downloading the file to memory (FLASH / DRAM/CARD)</b>	* The space of memory is full.	* Delete unused files in the memory.

<b>SD card is unable to use</b>	<ul style="list-style-type: none"> <li>* SD card is damaged.</li> <li>* SD card doesn't insert correctly.</li> <li>* Use the non-approved SD card manufacturer.</li> </ul>	<ul style="list-style-type: none"> <li>* Use the supported capacity SD card.</li> <li>* Insert the SD card again.</li> <li>* The supported SD card spec and the approved SD card manufacturers, please refer to section 2.2.3.</li> </ul>
<b>Poor Print Quality</b>	<ul style="list-style-type: none"> <li>* Ribbon and media is loaded incorrectly</li> <li>* Dust or adhesive accumulation on the print head.</li> <li>* Print density is not set properly.</li> <li>* Printhead element is damaged.</li> <li>* Ribbon and media are incompatible.</li> <li>* The printhead pressure is not set properly.</li> </ul>	<ul style="list-style-type: none"> <li>* Reload the supply.</li> <li>* Clean the print head.</li> <li>* Clean the platen roller.</li> <li>* Adjust the print density and print speed.</li> <li>* Run printer self-test and check the print head test pattern if there is dot missing in the pattern.</li> <li>* Change proper ribbon or proper label media.</li> <li>* Adjust the printhead pressure adjustment knob.</li> <li>* The release lever does not latch the printhead properly.</li> </ul>
<b>Missing printing on the left or right side of label</b>	<ul style="list-style-type: none"> <li>* Wrong label size setup.</li> </ul>	<ul style="list-style-type: none"> <li>* Set the correct label size.</li> </ul>
<b>Gray line on the blank label</b>	<ul style="list-style-type: none"> <li>* The print head is dirty.</li> <li>* The platen roller is dirty.</li> </ul>	<ul style="list-style-type: none"> <li>* Clean the print head.</li> <li>* Clean the platen roller.</li> </ul>
<b>Irregular printing</b>	<ul style="list-style-type: none"> <li>* The printer is in Hex Dump mode.</li> <li>* The RS-232 setting is incorrect.</li> </ul>	<ul style="list-style-type: none"> <li>* Turn off and on the printer to skip the dump mode.</li> <li>* Re-set the Rs-232 setting.</li> </ul>
<b>Label feeding is not stable (skew) when printing</b>	<ul style="list-style-type: none"> <li>* The media guide does not touch the edge of the media.</li> </ul>	<ul style="list-style-type: none"> <li>* If the label is moving to the right side, please move the label guide to left.</li> <li>* If the label is moving to the left side, please move the label guide to right.</li> </ul>
<b>Skip labels when printing</b>	<ul style="list-style-type: none"> <li>* Label size is not specified properly.</li> <li>* Sensor sensitivity is not set properly.</li> <li>* The media sensor is covered with dust.</li> </ul>	<ul style="list-style-type: none"> <li>* Check if label size is setup correctly.</li> <li>* Calibrate the sensor by Auto Gap or Manual Gap options.</li> <li>* Clear the GAP/Black mark sensor by blower.</li> </ul>
<b>Wrinkle Problem</b>	<ul style="list-style-type: none"> <li>* Printhead pressure is incorrect.</li> <li>* Ribbon installation is incorrect.</li> <li>* Media installation is incorrect.</li> <li>* Print density is incorrect.</li> <li>* Media feeding is incorrect.</li> </ul>	<ul style="list-style-type: none"> <li>* Please refer to chapter 4.4.</li> <li>* Please set the suitable density to have good print quality.</li> <li>* Make sure the label guide touch the edge of the media guide.</li> </ul>
<b>RTC time is incorrect when reboot the printer</b>	<ul style="list-style-type: none"> <li>* The battery has run down.</li> </ul>	<ul style="list-style-type: none"> <li>* Check if there is a battery on the main board.</li> </ul>
<b>The left side printout position is incorrect</b>	<ul style="list-style-type: none"> <li>* Wrong label size setup.</li> <li>* The parameter Shift X in LCD menu is incorrect.</li> </ul>	<ul style="list-style-type: none"> <li>* Set the correct label size.</li> <li>* Press [MENU] → [SELECT] x 3 → [DOWN] x 5 → [SELECT] to fine tune the parameter of Shift X.</li> </ul>

**The printing position of small label is incorrect**

- \* Media sensor sensitivity is not set properly.
- \* Label size is incorrect.
- \* The parameter Shift Y in the LCD menu is incorrect.
- \* The vertical offset setting in the driver is incorrect.

- \* Calibrate the sensor sensitivity again.
- \* Set the correct label size and gap size.
- \* Press [MENU] → [SELECT] x3 → [DOWN] x6 → [SELECT] to fine tune the parameter of Shift Y.
- \* If using the software BarTender, please set the vertical offset in the driver.

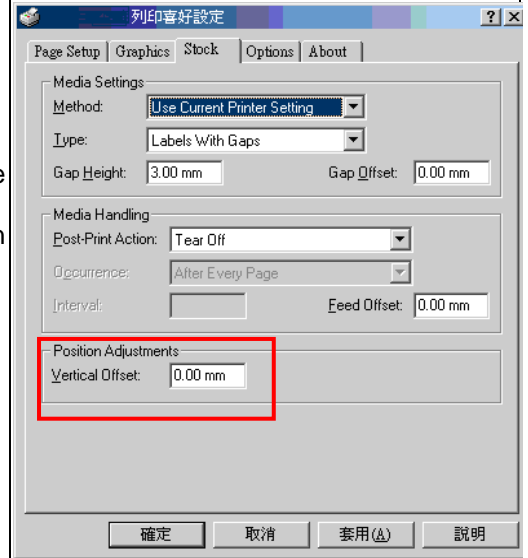

## 9. Maintenance

This session presents the clean tools and methods to maintain your printer.

1. Please use one of following material to clean the printer.

- Cotton swab
- Lint-free cloth
- Vacuum / Blower brush
- 100% Ethanol or Isopropyl Alcohol

2. The cleaning process is described as following,

Printer Part	Method	Interval
<b>Print Head</b>	1. Always turn off the printer before cleaning the print head. 2. Allow the print head to cool for a minimum of one minute. 3. Use a cotton swab and 100% Ethanol or Isopropyl Alcohol to clean the print head surface.	Clean the print head when changing a new label roll.
<b>Platen Roller</b>	1. Turn the power off. 2. Rotate the platen roller and wipe it thoroughly with water.	Clean the platen roller when changing a new label roll
<b>Peel Bar</b>	Use the lint-free cloth with 100% ethanol to wipe it.	As needed
<b>Sensor</b>	Compressed air or vacuum	Monthly
<b>Exterior</b>	Wipe it with water-dampened cloth	As needed
<b>Interior</b>	Brush or vacuum	As needed

### Note:

- Do not touch printer head by hand. If you touch it careless, please use ethanol to clean it.
- Please use 100% Ethenol or Isopropyl Alcohol. DO NOT use medical alcohol, which may damage the printer head.
- Regularly clean the print head and supply sensors once change a new media to keep printer performance and extend printer life.

## Revise History

---

Date	Content	Editor
2015/6/26	Modify section 1.6	Camille
2015/7/31	Modify section 3.3.3 (Loading media in peel-off mode)	Camille
2015/10/19	Modify section 2.2.3 (Recommended SD card specification)	Camille
2015/11/9	Add section 4.2 (Ribbon Tension Adjustment Module) Modify section 4.4 (Mechanism Fine Adjustment to Avoid Ribbon Wrinkles)	Camille
2016/5/27	Modify section 1.5, 5.3, 5.4, 5.5 and 6.3	Camille







**Nederland**  
Nieuwland Parc 159  
3351 LJ Papendrecht  
Tel: +31(0)78 615 20 33  
E-mail: [info@altec.nl](mailto:info@altec.nl)  
Website: [www.altec.nl](http://www.altec.nl)

**België**  
Erasmuslaan 11  
1804 Eppegem  
Tel: +32(0)2 270 34 88  
E-mail: [info@altec.be](mailto:info@altec.be)  
Website: [www.altec.be](http://www.altec.be)